

Contact insert module - HC-M-08-PT-F



1424226

<https://www.phoenixcontact.com/pc/products/1424226>

Please be informed that the data shown in this PDF document is generated from our Online Catalog. Please find the complete data in the user documentation. Our General Terms of Use for Downloads are valid.



Contact insert module, number of positions: 8, power contacts: 8, control contacts: 0, Socket, Push-in connection, 400 V, 16 A, 0.5 mm² ... 2.5 mm², application: Power

Your advantages

- Easy installation without tools, even when mounted, with push-in connection technology
- Shortest installation time compared to other connection technologies
- Quick and effortless wiring, in particular when space is tight
- Automatic cabling with robots possible
- Safe wiring and operation with color-coded actuators
- Shock and vibration-resistant in accordance with DIN EN 61373

Commercial Data

| | |
|--------------------------------------|---------------------|
| Item number | 1424226 |
| Packing unit | 1 pc |
| Minimum order quantity | 1 pc |
| Product Key | BF7ACE |
| Catalog Page | Page 577 (C-2-2019) |
| GTIN | 4055626369570 |
| Weight per Piece (including packing) | 22.5 g |
| Weight per Piece (excluding packing) | 20.41 g |
| Customs tariff number | 85366990 |
| Country of origin | CN |

Contact insert module - HC-M-08-PT-F



1424226

<https://www.phoenixcontact.com/pc/products/1424226>

Technical Data

Notes

| | |
|---------|---|
| General | for flexible conductors with or without ferrules |
| General | Connectors may be operated only when there is no load/voltage. |
| General | Flexible conductors may be used without ferrules as long as they comply with IEC 60228 Class 1 ... 5. The individual litz wires must have a min. diameter of 0.17 mm. |
| General | For HEAVYCON housing type B6 ... B48 and module carrier frame HC-M-B...MF-... |

Product properties

| | |
|-------------------------|------------------------|
| Product type | Modular contact insert |
| Number of positions | 8 |
| Connection profile | 8 |
| Application | Power |
| Number of module slots | 1 |
| No. of power contacts | 8 |
| No. of control contacts | 0 |
| Contact type | turned |
| Series | HC-M-08 |

Insulation characteristics

| | |
|----------------------|-----|
| Overvoltage category | III |
| Degree of pollution | 3 |

Connection data

Connection technology

| | |
|-----------------------|--------------------|
| Connection technology | Push-in connection |
|-----------------------|--------------------|

Conductor connection

| | |
|---|---|
| Conductor cross section | 0.5 mm ² ... 2.5 mm ² |
| Connection cross section AWG | 20 ... 14 |
| Stripping length of the individual wire | 10 mm |

Dimensions

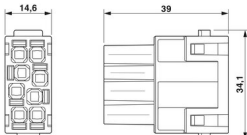
| | |
|---------------------|--|
| Dimensional drawing |  |
| Width | 34.1 mm |
| Height | 39 mm |
| Length | 14.6 mm |

Contact insert module - HC-M-08-PT-F



1424226

<https://www.phoenixcontact.com/pc/products/1424226>

Mechanical characteristics

| | |
|------------------|--------|
| Contact diameter | 2.5 mm |
|------------------|--------|

Electrical properties

| | |
|--------------------------------|-----------------------|
| Rated voltage (III/2) contacts | 690 V |
| Rated voltage (III/3) | 400 V |
| Rated surge voltage (III/2) | 4 kV |
| Rated surge voltage (III/3) | 6 kV |
| Rated surge voltage | 4 kV |
| Rated current | 16 A (power contacts) |

Material specifications

| | |
|--|--------------|
| Flammability rating according to UL 94 | V0 |
| Contact material | Copper alloy |
| Contact surface material | Ag |
| Contact carrier material | PC |

Connector

| | |
|-----------------------------|-------|
| Insertion/withdrawal cycles | ≥ 500 |
|-----------------------------|-------|

Cable / line

| | |
|---|-------|
| Stripping length of the individual wire | 10 mm |
|---|-------|

Mounting

| | |
|-----------------------|---|
| Assembly instructions | To ensure correct use, installation in housing with IP54 protection or better is required |
|-----------------------|---|

Ambient conditions

| | |
|---------------------------------|-------------------|
| Ambient temperature (operation) | -40 °C ... 125 °C |
|---------------------------------|-------------------|

Contact insert module - HC-M-08-PT-F

1424226

<https://www.phoenixcontact.com/pc/products/1424226>

Drawings

Dimensional drawing

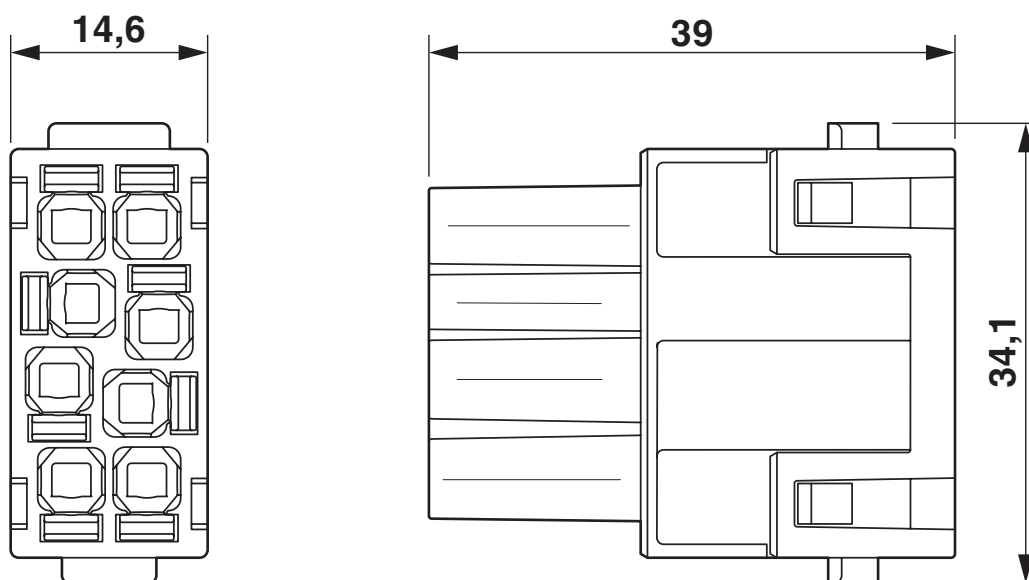

Dimensional drawing

Diagram

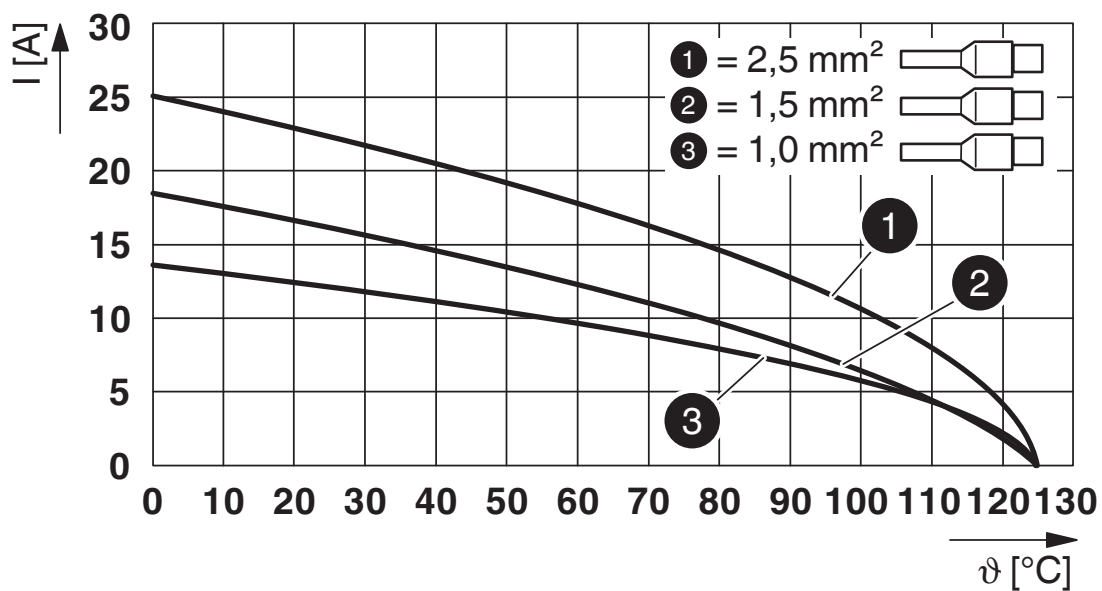

Derating diagram for flexible conductors with ferrule

Contact insert module - HC-M-08-PT-F

1424226

<https://www.phoenixcontact.com/pc/products/1424226>

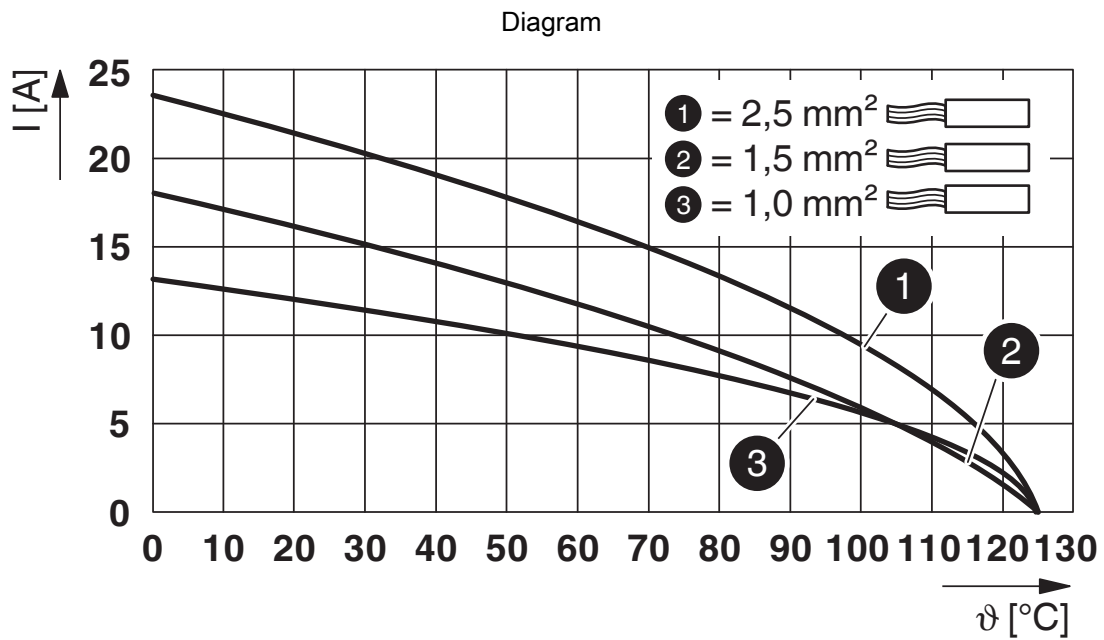

Derating diagram for flexible conductors

Contact insert module - HC-M-08-PT-F

1424226

<https://www.phoenixcontact.com/pc/products/1424226>



Schematic diagram

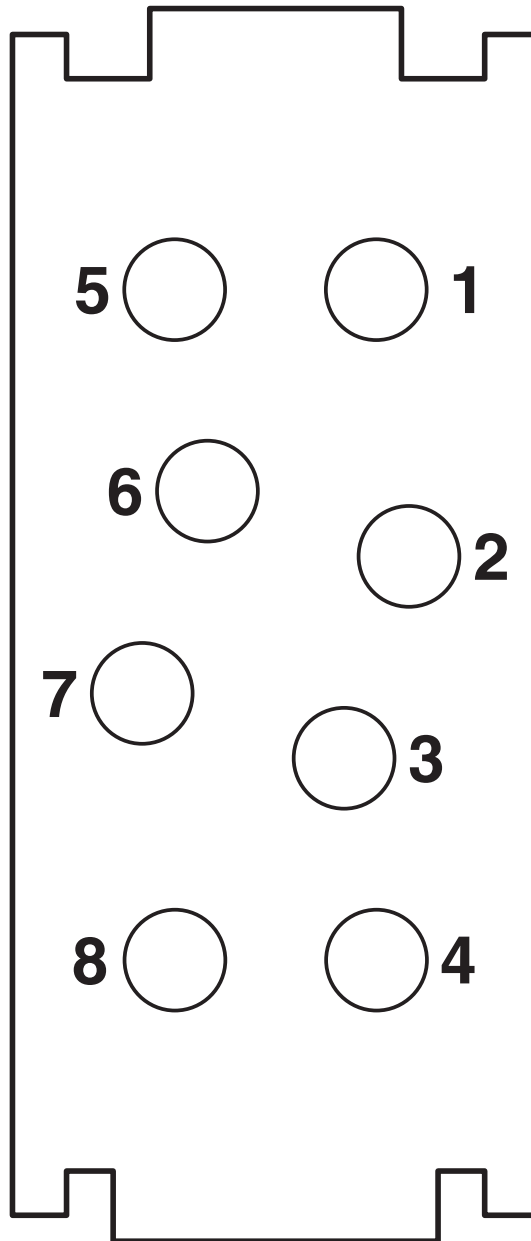

Connector pin assignment, connection side

Contact insert module - HC-M-08-PT-F



1424226

<https://www.phoenixcontact.com/pc/products/1424226>

Approvals



EAC

Approval ID: RU C-DE.AI30.B.01102



EAC

Approval ID: RU C-DE.BL08.B.00511



UL Recognized

Approval ID: E468743

| | Nominal Voltage U_N | Nominal Current I_N | Cross Section AWG | Cross Section mm^2 |
|--|-----------------------|-----------------------|-------------------|-----------------------------|
| | 600 V | 16 A | - 14 | - |

Contact insert module - HC-M-08-PT-F



1424226

<https://www.phoenixcontact.com/pc/products/1424226>

Classifications

ECLASS

| | |
|---------------|----------|
| ECLASS-9.0 | 27440217 |
| ECLASS-10.0.1 | 27440217 |
| ECLASS-11.0 | 27440217 |

ETIM

| | |
|----------|----------|
| ETIM 8.0 | EC000438 |
|----------|----------|

UNSPSC

| | |
|-------------|----------|
| UNSPSC 21.0 | 39121400 |
|-------------|----------|

Contact insert module - HC-M-08-PT-F



1424226

<https://www.phoenixcontact.com/pc/products/1424226>

Environmental Product Compliance

| | |
|------------|---|
| China RoHS | Environmentally friendly use period: unlimited = EFUP-e No hazardous substances above threshold values |
|------------|---|

Contact insert module - HC-M-08-PT-F

1424226

<https://www.phoenixcontact.com/pc/products/1424226>

Accessories

Coding element

Coding element - HC-CBU-MOD - 1636130

<https://www.phoenixcontact.com/pc/products/1636130>

Coding socket for coding up to 16 connectors, for HC Modular



Coding element

Coding element - HC-CST-MOD - 1636127

<https://www.phoenixcontact.com/pc/products/1636127>

Coding peg for coding up to 16 connectors, for HC Modular



Contact insert module - HC-M-08-PT-F

1424226

<https://www.phoenixcontact.com/pc/products/1424226>

Module carrier frame

Module carrier frame - HC-M-B06-MFH-B - 1182085

<https://www.phoenixcontact.com/pc/products/1182085>

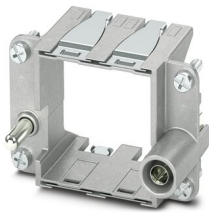

Module carrier frame, size: B6, type : for the panel mounting side (a, b, c, ...), 4 mm² ... 6 mm², application: Module carrier frame

Module carrier frame

Module carrier frame - HC-M-B10-MFH-B - 1182088

<https://www.phoenixcontact.com/pc/products/1182088>

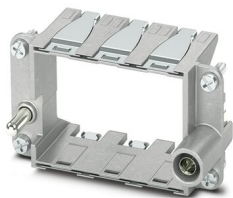

Module carrier frame, size: B10, type : for the panel mounting side (a, b, c, ...), 4 mm² ... 6 mm², application: Module carrier frame

Contact insert module - HC-M-08-PT-F

1424226

<https://www.phoenixcontact.com/pc/products/1424226>

Module carrier frame

Module carrier frame - HC-M-B16-MFH-B - 1182090

<https://www.phoenixcontact.com/pc/products/1182090>

Module carrier frame, size: B16, type : for the panel mounting side (a, b, c, ...), 4 mm² ... 6 mm², application: Module carrier frame



Module carrier frame

Module carrier frame - HC-M-B24-MFH-B - 1182094

<https://www.phoenixcontact.com/pc/products/1182094>

Module carrier frame, size: B24, type : for the panel mounting side (a, b, c, ...), 4 mm² ... 6 mm², application: Module carrier frame



Contact insert module - HC-M-08-PT-F

1424226

<https://www.phoenixcontact.com/pc/products/1424226>

Module carrier frame

Module carrier frame - HC-M-B06-MFH-H - 1182087

<https://www.phoenixcontact.com/pc/products/1182087>



Module carrier frame, size: B6, type : for the sleeve side (A, B, C, ...), 4 mm² ... 6 mm², application: Module carrier frame

Module carrier frame

Module carrier frame - HC-M-B10-MFH-H - 1182089

<https://www.phoenixcontact.com/pc/products/1182089>



Module carrier frame, size: B10, type : for the sleeve side (A, B, C, ...), 4 mm² ... 6 mm², application: Module carrier frame

Contact insert module - HC-M-08-PT-F

1424226

<https://www.phoenixcontact.com/pc/products/1424226>

Module carrier frame

Module carrier frame - HC-M-B16-MFH-H - 1182093

<https://www.phoenixcontact.com/pc/products/1182093>

Module carrier frame, size: B16, type : for the sleeve side (A, B, C, ...), 4 mm² ...
6 mm², application: Module carrier frame

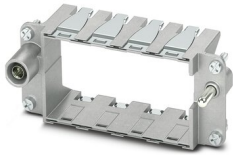

Module carrier frame

Module carrier frame - HC-M-B24-MFH-H - 1182095

<https://www.phoenixcontact.com/pc/products/1182095>

Module carrier frame, size: B24, type : for the sleeve side (A, B, C, ...), 4 mm² ...
6 mm², application: Module carrier frame



Contact insert module - HC-M-08-PT-F

1424226

<https://www.phoenixcontact.com/pc/products/1424226>

Crimping pliers

Crimping pliers - CRIMPFOX CENTRUS 6S - 1213144

<https://www.phoenixcontact.com/pc/products/1213144>



Crimping pliers, for uninsulated and insulated ferrules, DIN 46228 Part 1 and 4, from 0.14 mm² ... 6 mm², also for TWIN ferrules up to 2 x 4 mm², automatic cross section adjustment, lateral insertion, equipped with fall protection

Crimping pliers

Crimping pliers - CRIMPFOX 6 - 1212034

<https://www.phoenixcontact.com/pc/products/1212034>



Crimping pliers, for ferrules without insulating collar according to DIN 46228 Part 1 and ferrules with insulating collar according to DIN 46228 Part 4, 0.25 mm² ... 6.0 mm², lateral entry, trapezoidal crimp

Contact insert module - HC-M-08-PT-F

1424226

<https://www.phoenixcontact.com/pc/products/1424226>

Electrical crimping tool

Electrical crimping tool - CF CRIMPHANDY 0,5 - 1212463

<https://www.phoenixcontact.com/pc/products/1212463>



Mobile handheld device, battery-powered, for processing on-tape ferrules 0.5 mm² with functional end, suitable for PVC insulated conductors (H05V-K), incl. battery, charger, CUTFOX 12 cable cutter, waste guide plate 2, service tool for error correction, and one strip of ferrules 0.5 mm², packed in a robust case.

Electrical crimping tool

Electrical crimping tool - CF CRIMPHANDY 0,75 - 1212464

<https://www.phoenixcontact.com/pc/products/1212464>



Mobile handheld device, battery-powered, for processing on-tape ferrules 0.75 mm² with functional end, suitable for PVC insulated conductors (H05V-K), incl. battery, charger, CUTFOX 12 cable cutter, waste guide plate 2, service tool for error correction, and one strip of ferrules 0.75 mm², packed in a robust case.

Contact insert module - HC-M-08-PT-F

1424226

<https://www.phoenixcontact.com/pc/products/1424226>

Electrical crimping tool

Electrical crimping tool - CF CRIMPHANDY 1,0 - 1212465

<https://www.phoenixcontact.com/pc/products/1212465>



Mobile handheld device, battery-powered, for processing on-tape ferrules 1.0 mm² with functional end, suitable for PVC insulated conductors (H05V-K), incl. battery, charger, CUTFOX 12 cable cutter, waste guide plate 2, service tool for error correction, and one strip of ferrules 1.0 mm², packed in a robust case.

Electrical crimping tool

Electrical crimping tool - CF CRIMPHANDY 1,5 - 1212466

<https://www.phoenixcontact.com/pc/products/1212466>



Mobile handheld device, battery-powered, for processing on-tape ferrules 1.5 mm² with functional end, suitable for PVC insulated conductors (H07V-K), incl. battery, charger, CUTFOX 12 cable cutter, waste guide plate 2, service tool for error correction, and one strip of ferrules 1.5 mm², packed in a robust case.

Contact insert module - HC-M-08-PT-F



1424226

<https://www.phoenixcontact.com/pc/products/1424226>

Contact insert module

Contact insert module - HC-M-08-PT-M - 1424227

<https://www.phoenixcontact.com/pc/products/1424227>



Contact insert module, number of positions: 8, power contacts: 8, control contacts: 0, Pin, Push-in connection, 400 V, 16 A, 0.5 mm² ... 2.5 mm², application: Power

Phoenix Contact 2022 © - all rights reserved

<https://www.phoenixcontact.com>

PHOENIX CONTACT GmbH & Co. KG

Flachsmarktstraße 8

D-32825 Blomberg

+49 (0) 5235-3 00

info@phoenixcontact.com