

Contact insert module - HC-M-RJ45-AD-PC-M



1419885

<https://www.phoenixcontact.com/nl/producten/1419885>

Please be informed that the data shown in this PDF document is generated from our Online Catalog. Please find the complete data in the user documentation. Our General Terms of Use for Downloads are valid.

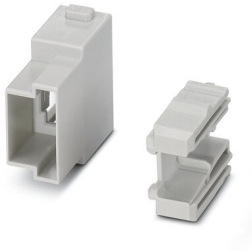

Contact insert module, number of positions: RJ45, type : RJ45, Pin, 48 V, 1 A, application: Data, with adapter for patch cables

Commercial Data

Item number	1419885
Packing unit	1 pc
Minimum order quantity	1 pc
Sales Key	BF7ACE
Product Key	BF7ACE
Catalog Page	Page 591 (C-2-2019)
GTIN	4055626253237
Weight per Piece (including packing)	12,8 g
Weight per Piece (excluding packing)	12,2 g
Customs tariff number	85389099
Country of origin	PL

Contact insert module - HC-M-RJ45-AD-PC-M



1419885

<https://www.phoenixcontact.com/nl/producten/1419885>

Technical Data

Notes

General	Use the patch cable from the accessories list.
General	Connectors may be operated only when there is no load/voltage.

Product properties

Product type	Modular contact insert
Number of positions	8
Connection profile	RJ45
Application	Data
Number of module slots	1
Type	RJ45
Series	HC-M-RJ45

Insulation characteristics

Overvoltage category	III
Degree of pollution	3

Dimensions

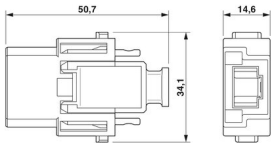
Dimensional drawing	
Width	34.2 mm
Height	50.7 mm
Length	14.6 mm

Mechanical characteristics

Minimum housing height	72 mm
------------------------	-------

Electrical properties

Rated voltage (III/3)	48 V
Rated surge voltage	0.8 kV
Rated current	1 A

Material specifications

Color	light grey
Flammability rating according to UL 94	V0
Contact material	Copper alloy
Contact surface material	Au
Contact carrier material	PC
Standards/regulations	PC: Fire protection in rail vehicles - requirement sets R22, R23, and R24 acc. to DIN EN 45545-2 (Risk level HL1 - HL3)

Contact insert module - HC-M-RJ45-AD-PC-M



1419885

<https://www.phoenixcontact.com/nl/producten/1419885>

Connector

Insertion/withdrawal cycles

≥ 500

Mounting

Assembly instructions

To ensure correct use, installation in housing with IP54 protection or better is required

Ambient conditions

Ambient temperature (operation)

-25 °C ... 60 °C

Standards and regulations

Testing

Standards/regulations

PC: Fire protection in rail vehicles - requirement sets R22, R23, and R24 acc. to DIN EN 45545-2 (Risk level HL1 - HL3)

Contact insert module - HC-M-RJ45-AD-PC-M

1419885

<https://www.phoenixcontact.com/nl/producten/1419885>



Drawings

Dimensional drawing

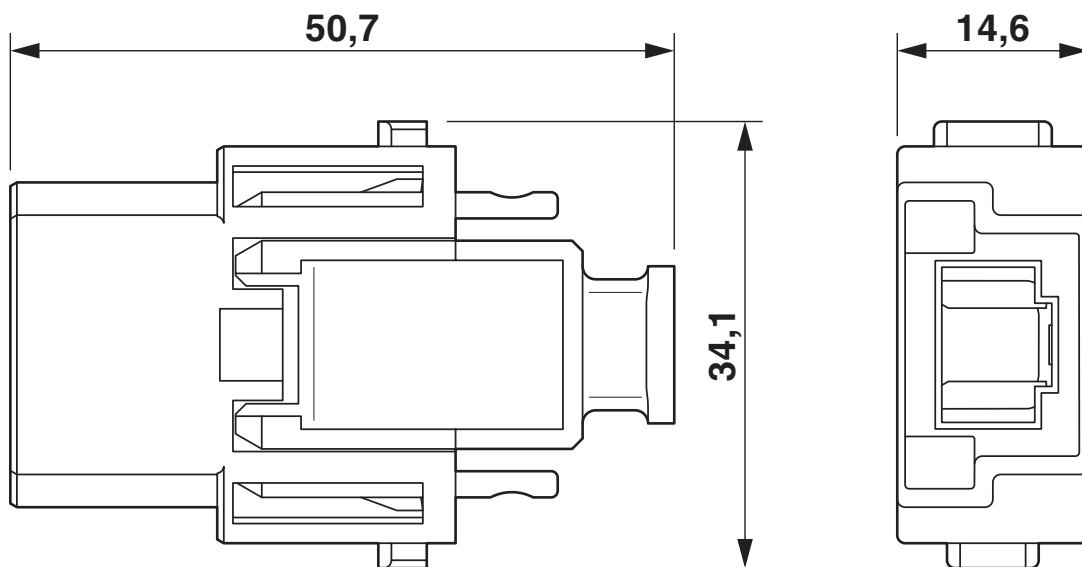

Male insert

Contact insert module - HC-M-RJ45-AD-PC-M



1419885

<https://www.phoenixcontact.com/nl/producten/1419885>

Approvals

DNV

Approval ID: TAE000037S



CSA

Approval ID: 13631



UL Recognized

Approval ID: E118976



EAC

Approval ID: RU C-DE.AI30.B.01102



EAC

Approval ID: RU C-DE.BL08.B.00511

Contact insert module - HC-M-RJ45-AD-PC-M



1419885

<https://www.phoenixcontact.com/nl/producten/1419885>

Classifications

ECLASS

ECLASS-9.0	27440218
ECLASS-10.0.1	27440218
ECLASS-11.0	27440218

ETIM

ETIM 8.0	EC000438
----------	----------

UNSPSC

UNSPSC 21.0	39121400
-------------	----------

Contact insert module - HC-M-RJ45-AD-PC-M



1419885

<https://www.phoenixcontact.com/nl/producten/1419885>

Environmental Product Compliance

China RoHS	Environmentally friendly use period: unlimited = EFUP-e
	No hazardous substances above threshold values

Contact insert module - HC-M-RJ45-AD-PC-M

1419885

<https://www.phoenixcontact.com/nl/producten/1419885>

Accessories

Coding element

Coding element - HC-CBU-MOD - 1636130

<https://www.phoenixcontact.com/nl/producten/1636130>

Coding socket for coding up to 16 connectors, for HC Modular



Coding element

Coding element - HC-CST-MOD - 1636127

<https://www.phoenixcontact.com/nl/producten/1636127>

Coding peg for coding up to 16 connectors, for HC Modular



Contact insert module - HC-M-RJ45-AD-PC-M

1419885

<https://www.phoenixcontact.com/nl/producten/1419885>

Patch cable

Patch cable - FL CAT5 PATCH 0,3 - 2832250

<https://www.phoenixcontact.com/nl/producten/2832250>



Patch cable, CAT5, assembled, 0.3 m

Patch cable

Patch cable - FL CAT5 PATCH 0,5 - 2832263

<https://www.phoenixcontact.com/nl/producten/2832263>



Patch cable, CAT5, assembled, 0.5 m

Contact insert module - HC-M-RJ45-AD-PC-M

1419885

<https://www.phoenixcontact.com/nl/producten/1419885>

Patch cable

Patch cable - FL CAT5 PATCH 1,0 - 2832276

<https://www.phoenixcontact.com/nl/producten/2832276>



Patch cable, CAT5, assembled, 1 m

Patch cable

Patch cable - FL CAT5 PATCH 1,5 - 2832221

<https://www.phoenixcontact.com/nl/producten/2832221>



Patch cable, CAT5, assembled, 1.5 m

Contact insert module - HC-M-RJ45-AD-PC-M

1419885

<https://www.phoenixcontact.com/nl/producten/1419885>

Patch cable

Patch cable - FL CAT5 PATCH 2,0 - 2832289

<https://www.phoenixcontact.com/nl/producten/2832289>



Patch cable, CAT5, assembled, 2 m

Patch cable

Patch cable - FL CAT5 PATCH 3,0 - 2832292

<https://www.phoenixcontact.com/nl/producten/2832292>



Patch cable, CAT5, assembled, 3 m

Contact insert module - HC-M-RJ45-AD-PC-M

1419885

<https://www.phoenixcontact.com/nl/producten/1419885>

Patch cable

Patch cable - FL CAT5 PATCH 5,0 - 2832580

<https://www.phoenixcontact.com/nl/producten/2832580>



Patch cable, CAT5, assembled, 5 m

Patch cable

Patch cable - FL CAT5 PATCH 7,5 - 2832616

<https://www.phoenixcontact.com/nl/producten/2832616>



Patch cable, CAT5, assembled, 7.5 m

Contact insert module - HC-M-RJ45-AD-PC-M

1419885

<https://www.phoenixcontact.com/nl/producten/1419885>

Patch cable

Patch cable - FL CAT5 PATCH 10,0 - 2832629

<https://www.phoenixcontact.com/nl/producten/2832629>

Patch cable, CAT5, assembled, 10 m



Patch cable

Patch cable - FL CAT6 PATCH 0,3 - 2891181

<https://www.phoenixcontact.com/nl/producten/2891181>

Patch cable, CAT6, pre-assembled, 0.3 m



Contact insert module - HC-M-RJ45-AD-PC-M

1419885

<https://www.phoenixcontact.com/nl/producten/1419885>

Patch cable

Patch cable - FL CAT6 PATCH 0,5 - 2891288

<https://www.phoenixcontact.com/nl/producten/2891288>

Patch cable, CAT6, pre-assembled, 0.5 m



Patch cable

Patch cable - FL CAT6 PATCH 1,0 - 2891385

<https://www.phoenixcontact.com/nl/producten/2891385>

Patch cable, CAT6, pre-assembled, 1.0 m

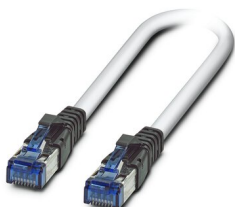

Contact insert module - HC-M-RJ45-AD-PC-M

1419885

<https://www.phoenixcontact.com/nl/producten/1419885>

Patch cable

Patch cable - FL CAT6 PATCH 1,5 - 2891482

<https://www.phoenixcontact.com/nl/producten/2891482>

Patch cable, CAT6, pre-assembled, 1.5 m



Patch cable

Patch cable - FL CAT6 PATCH 2,0 - 2891589

<https://www.phoenixcontact.com/nl/producten/2891589>

Patch cable, CAT6, pre-assembled, 2.0 m

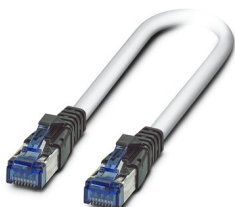

Contact insert module - HC-M-RJ45-AD-PC-M

1419885

<https://www.phoenixcontact.com/nl/producten/1419885>

Patch cable

Patch cable - FL CAT6 PATCH 3,0 - 2891686

<https://www.phoenixcontact.com/nl/producten/2891686>



Patch cable, CAT6, pre-assembled, 3.0 m

Patch cable

Patch cable - FL CAT6 PATCH 5,0 - 2891783

<https://www.phoenixcontact.com/nl/producten/2891783>

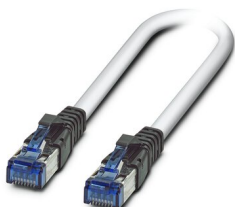

Patch cable, CAT6, pre-assembled, 5.0 m

Contact insert module - HC-M-RJ45-AD-PC-M

1419885

<https://www.phoenixcontact.com/nl/producten/1419885>

Patch cable

Patch cable - FL CAT6 PATCH 7,5 - 2891880

<https://www.phoenixcontact.com/nl/producten/2891880>

Patch cable, CAT6, pre-assembled, 7.5 m

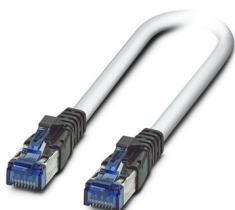

Patch cable

Patch cable - FL CAT6 PATCH 10 - 2891877

<https://www.phoenixcontact.com/nl/producten/2891877>

Patch cable, CAT6, pre-assembled, 10 m

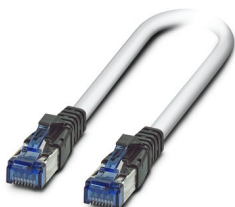

Contact insert module - HC-M-RJ45-AD-PC-M

1419885

<https://www.phoenixcontact.com/nl/producten/1419885>

Patch cable

Patch cable - FL CAT6 PATCH 12,5 - 2891369

<https://www.phoenixcontact.com/nl/producten/2891369>

Patch cable, CAT6, pre-assembled, 12.5 m



Patch cable

Patch cable - FL CAT6 PATCH 15,0 - 2891372

<https://www.phoenixcontact.com/nl/producten/2891372>

Patch cable, CAT6, pre-assembled, 15.0 m

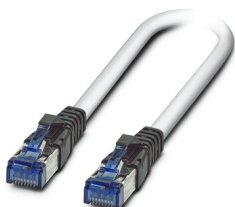

Contact insert module - HC-M-RJ45-AD-PC-M

1419885

<https://www.phoenixcontact.com/nl/producten/1419885>

Patch cable

Patch cable - FL CAT6 PATCH 20,0 - 2891576

<https://www.phoenixcontact.com/nl/producten/2891576>

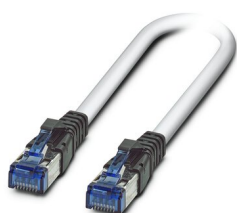

Patch cable, CAT6, pre-assembled, 20.0 m

Patch cable

Patch cable - NBC-R4AC1/0,3-94G/R4AC1-BU - 1413158

<https://www.phoenixcontact.com/nl/producten/1413158>

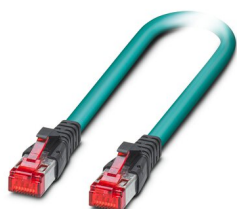

Patch cable, degree of protection: IP20, cable length: 0.3 m, number of positions: 8, 10 Gbps, CAT6_A, Ethernet

Contact insert module - HC-M-RJ45-AD-PC-M



1419885

<https://www.phoenixcontact.com/nl/producten/1419885>

Patch cable

Patch cable - NBC-R4AC1/0,5-94G/R4AC1-BU - 1413159

<https://www.phoenixcontact.com/nl/producten/1413159>

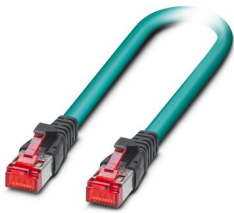

Patch cable, degree of protection: IP20, cable length: 0.5 m, number of positions: 8, 10 Gbps, CAT6_A, Ethernet

Patch cable

Patch cable - NBC-R4AC1/1,0-94G/R4AC1-BU - 1413160

<https://www.phoenixcontact.com/nl/producten/1413160>

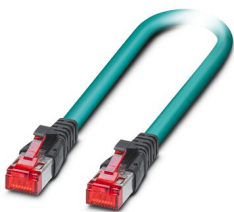

Patch cable, degree of protection: IP20, cable length: 1 m, number of positions: 8, 10 Gbps, CAT6_A, Ethernet

Contact insert module - HC-M-RJ45-AD-PC-M

1419885

<https://www.phoenixcontact.com/nl/producten/1419885>

Patch cable

Patch cable - NBC-R4AC1/2,0-94G/R4AC1-BU - 1413161

<https://www.phoenixcontact.com/nl/producten/1413161>

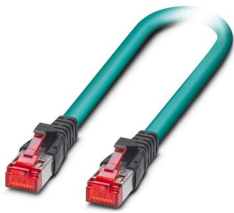

Patch cable, degree of protection: IP20, cable length: 2 m, number of positions: 8, 10 Gbps, CAT6_A, Ethernet

Patch cable

Patch cable - NBC-R4AC1/3,0-94G/R4AC1-BU - 1413162

<https://www.phoenixcontact.com/nl/producten/1413162>

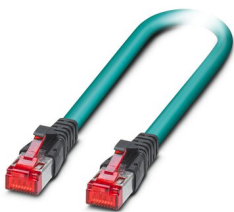

Patch cable, degree of protection: IP20, cable length: 3 m, number of positions: 8, 10 Gbps, CAT6_A, Ethernet

Contact insert module - HC-M-RJ45-AD-PC-M

1419885

<https://www.phoenixcontact.com/nl/producten/1419885>

Patch cable

Patch cable - NBC-R4AC1/5,0-94G/R4AC1-BU - 1413163

<https://www.phoenixcontact.com/nl/producten/1413163>

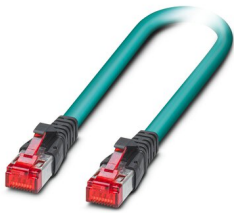

Patch cable, degree of protection: IP20, cable length: 5 m, number of positions: 8, 10 Gbps, CAT6_A, Ethernet

Patch cable

Patch cable - NBC-R4AC1/10,0-94G/R4AC1-BU - 1413164

<https://www.phoenixcontact.com/nl/producten/1413164>

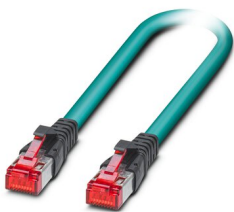

Patch cable, degree of protection: IP20, cable length: 10 m, number of positions: 8, 10 Gbps, CAT6_A, Ethernet

Contact insert module - HC-M-RJ45-AD-PC-M

1419885

<https://www.phoenixcontact.com/nl/producten/1419885>

Patch cable

Patch cable - NBC-R4AC1/15,0-94G/R4AC1-BU - 1413165

<https://www.phoenixcontact.com/nl/producten/1413165>

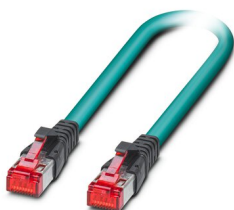

Patch cable, degree of protection: IP20, cable length: 15 m, number of positions: 8, 10 Gbps, CAT6_A, Ethernet

Patch cable

Patch cable - NBC-R4AC1/20,0-94G/R4AC1-BU - 1413166

<https://www.phoenixcontact.com/nl/producten/1413166>

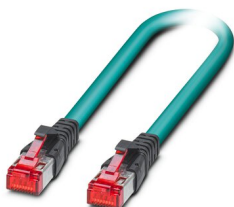

Patch cable, degree of protection: IP20, cable length: 20 m, number of positions: 8, 10 Gbps, CAT6_A, Ethernet

Contact insert module - HC-M-RJ45-AD-PC-M

1419885

<https://www.phoenixcontact.com/nl/producten/1419885>

Module carrier frame

Module carrier frame - HC-M-B06-MFH-B - 1182085

<https://www.phoenixcontact.com/nl/producten/1182085>

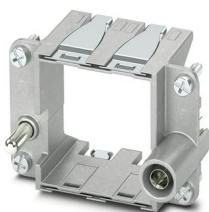

Module carrier frame, size: B6, type : for the panel mounting side (a, b, c, ...), 4 mm² ... 6 mm², application: Module carrier frame

Module carrier frame

Module carrier frame - HC-M-B10-MFH-B - 1182088

<https://www.phoenixcontact.com/nl/producten/1182088>



Module carrier frame, size: B10, type : for the panel mounting side (a, b, c, ...), 4 mm² ... 6 mm², application: Module carrier frame

Contact insert module - HC-M-RJ45-AD-PC-M

1419885

<https://www.phoenixcontact.com/nl/producten/1419885>

Module carrier frame

Module carrier frame - HC-M-B16-MFH-B - 1182090

<https://www.phoenixcontact.com/nl/producten/1182090>

Module carrier frame, size: B16, type : for the panel mounting side (a, b, c, ...), 4 mm² ... 6 mm², application: Module carrier frame



Module carrier frame

Module carrier frame - HC-M-B24-MFH-B - 1182094

<https://www.phoenixcontact.com/nl/producten/1182094>

Module carrier frame, size: B24, type : for the panel mounting side (a, b, c, ...), 4 mm² ... 6 mm², application: Module carrier frame



Contact insert module - HC-M-RJ45-AD-PC-M

1419885

<https://www.phoenixcontact.com/nl/producten/1419885>

Module carrier frame

Module carrier frame - HC-M-B06-MFH-H - 1182087

<https://www.phoenixcontact.com/nl/producten/1182087>



Module carrier frame, size: B6, type : for the sleeve side (A, B, C, ...), 4 mm² ... 6 mm², application: Module carrier frame

Module carrier frame

Module carrier frame - HC-M-B10-MFH-H - 1182089

<https://www.phoenixcontact.com/nl/producten/1182089>



Module carrier frame, size: B10, type : for the sleeve side (A, B, C, ...), 4 mm² ... 6 mm², application: Module carrier frame

Contact insert module - HC-M-RJ45-AD-PC-M

1419885

<https://www.phoenixcontact.com/nl/producten/1419885>

Module carrier frame

Module carrier frame - HC-M-B16-MFH-H - 1182093

<https://www.phoenixcontact.com/nl/producten/1182093>

Module carrier frame, size: B16, type : for the sleeve side (A, B, C, ...), 4 mm² ...
6 mm², application: Module carrier frame



Module carrier frame

Module carrier frame - HC-M-B24-MFH-H - 1182095

<https://www.phoenixcontact.com/nl/producten/1182095>

Module carrier frame, size: B24, type : for the sleeve side (A, B, C, ...), 4 mm² ...
6 mm², application: Module carrier frame



Contact insert module - HC-M-RJ45-AD-PC-M



1419885

<https://www.phoenixcontact.com/nl/producten/1419885>

Contact insert module

Contact insert module - HC-M-RJ45-08-GC-F/F - 1419886

<https://www.phoenixcontact.com/nl/producten/1419886>



Contact insert module, number of positions: RJ45, type : RJ45, Socket, 48 V, 1 A, application: Data, Gender changer

Phoenix Contact 2022 © - all rights reserved

<https://www.phoenixcontact.com>

PHOENIX CONTACT B.V.

Hengelder 56 6902 PA Zevenaar

Postbus 246 6900 AE Zevenaar

(0316) 59 17 20

sales@phoenixcontact.nl