

1

2

3

4

5

6

RevNo

Revision note

Date

Signature

Checked

A

B

C

D

AT5 Pulley with 22 Teeth
Designed for use with
25mm wide belts

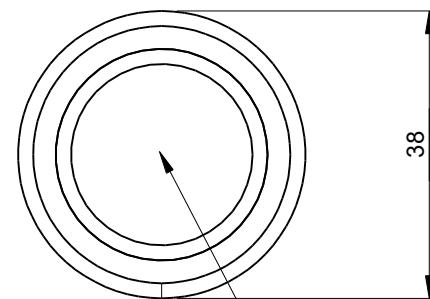
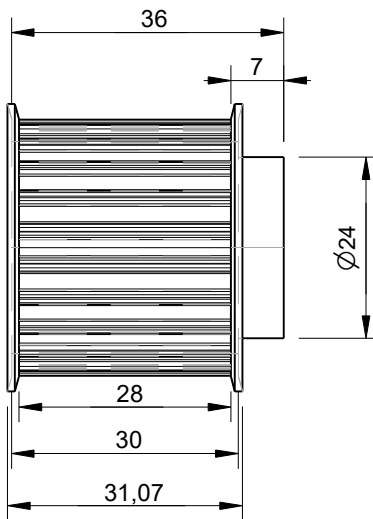
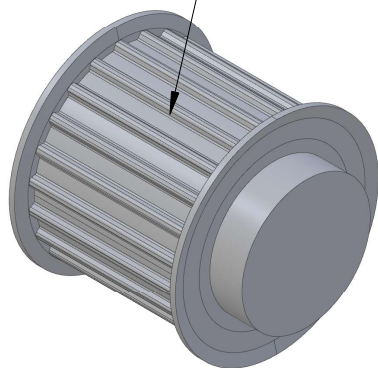

This AT5 pulley size
does not have a bore

Effective (Outer) Diameter	35.05mm
Pitch Diameter	33.85mm
Weight	0.08kg
With Flanges?	yes
Material	Aluminium
Units	mm
Tolerances	+/-0.1mm

Itemref	Quantity	Title/Name, designation, material, dimension etc			Article No./Reference	
Drawn by Kevin Damen		Checked by	Approved by - date	File name	Date 11-12-2023	Scale 1:1

6414

www.damencnc.com

6414 AT5 Pulley 36-AT5 Z=22
for 25mm wide belts

Edition

Sheet
1 OF 1

1

2

3

4

5

6