

1

2

3

4

5

6

RevNo	Revision note		Date	Signature	Checked
-------	---------------	--	------	-----------	---------

A

A

AT5 Pulley with 32 Teeth
Designed for use with
25mm wide belts

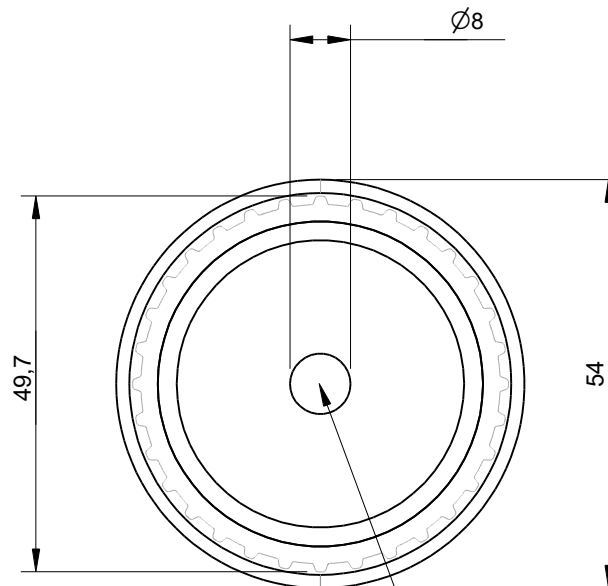
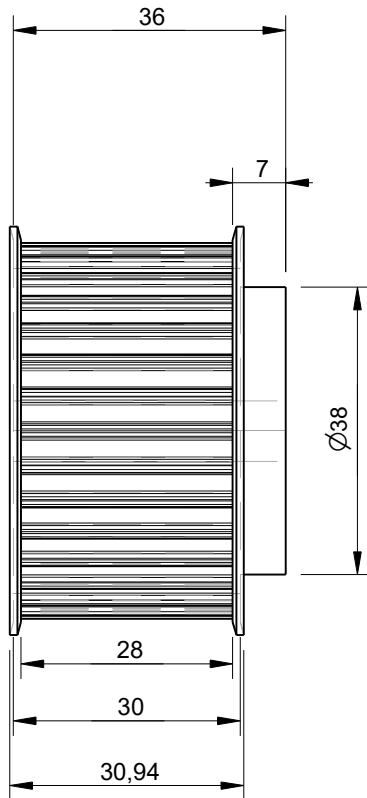
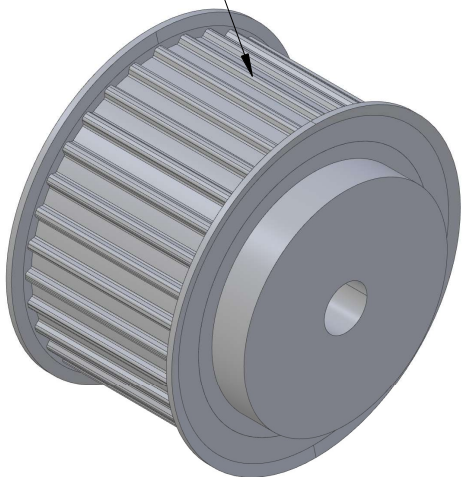

This AT5 pulley size
has a bore of 8mm

B

B

C

C

Effective (Outer) Diameter	49.70mm
Pitch Diameter	50.90mm
Weight	0.18kg
With Flanges?	yes
Material	Aluminium
Units	mm
Tolerances	+/-0.1mm

Itemref	Quantity	Title/Name, designation, material, dimension etc	Article No./Reference		
Drawn by Kevin Damen	Checked by	Approved by - date	File name	Date 13-12-2023	Scale 1:1

6421

www.damencnc.com

6421 AT5 Pulley 36-AT5 Z=32 for 25mm wide belts	Edition	Sheet 1 OF 1
--	---------	-----------------

1

2

3

4

5

6

D

D