

ELECTRIC CYLINDER SERIES ELEKTRO ISO 15552

An electric cylinder with a connection interface in accordance with ISO 15552.

The piston rod extension is controlled by a system with a hardened screw and recirculating ball screw nut. The piston has a guide strip calibrated to reduce to a minimum play with the barrel and hence vibration during ball screw rotation.

The cylinder can be equipped with a built-in non-rotating system featuring two opposing slides that run in separate longitudinal slots in the barrel.

The piston comes with magnets and the barrel has longitudinal slots for housing sensors. The piston rod has increased outside diameter and thickness to make it extra rigid and more resistant to radial and peak loads.

A system for greasing the screws is included. Numerous standard accessories for pneumatic cylinders, can be used for mounting the cylinder. Accessories made of aluminium, or made of steel for heavy-duty operations, can be used.

The motor can be selected from an optimised range, which encompasses both STEPPING and BRUSHLESS motors.

There is a version with a brake mounted on the motor.

Stepping motors are also available with a brake and encoder (all BRUSHLESS motors come with an encoder). It is important to remember that the brake is static type, so the motor must be stopped before the brake is engaged.

There is a version for in-line assembly, where the drive shaft is jointed directly onto the screw. There is also a geared motor version, where transmission is provided by pulleys and a cog belt with a transmission ratio of 1:1.

A planetary gearbox, in the case of a Ø 100 in-line cylinder, and pulleys with a non-unitary gear ratio, in the case of a Ø 80 and Ø 100 cylinder, can be used to increase the torque. Suitable motor drives are provided.

Special adaptor flanges and joints can be provided if the customer wishes to use a particular brand of motor.

N.B.: A piston rod anti-rotation system must be used. If the piston rod is not fixed firmly to an element, a flange or to any other device preventing it from rotating, a cylinder in the anti-rotation version must be used.

in-line version



geared version

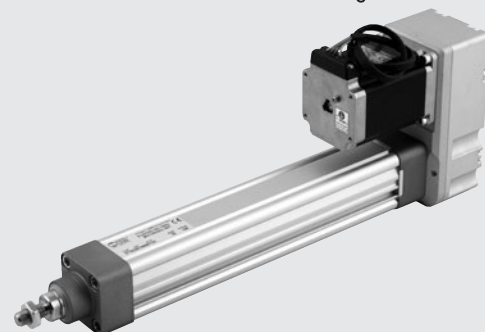

TECHNICAL DATA	Ø 32	Ø 50	Ø 63 - 63 HD	Ø 80	Ø 100
Piston rod thread	M10x1.25	M16x1.5	M16x1.5	M20x1.5	
Environmental temperature range for STEPPING motors	°C			from -10 to +50	
BRUSHLESS motors	°C			from 0 to +40	
Electrical protection rating with STEPPING motors	IP20/IP40 or IP55 (see key to codes on page A5.32)			IP55	
BRUSHLESS motors	IP40 or IP65 (see key to codes on page A5.32)			IP65	
Maximum relative humidity of the air for IP55 STEPPING motor	90% with 40°C; 57% with 50°C (no condensate)				
IP65 BRUSHLESS motor	90% (no condensate)				
Minimum stroke for version with non-rotating	Twice the screw pitch (to guarantee ball lubrication)				
Minimum stroke for version without non-rotating	mm		80 (in order to re-grease the screw)	125 (in order to re-grease the screw)	
Maximum stroke	mm		1370	1500	
Positioning repeatability	mm		± 0.02		
Positioning accuracy	mm		± 0.2 **		
Overall radial oscillation of the piston rod (without load) for 100 mm of stroke	mm		0.4		
Versions	With or without piston rod non-rotating			With or without piston rod non-rotating; in line or geared motor; with or without planetary gearbox	
Uncontrolled impact at the end of stroke	NOT ALLOWED (it provides an extra-stroke minimum 5 mm)				
Sensor magnet	YES				
Maximum angle of twist of the piston rod for non-rotating version	1°30'	1°	0°45'	0°35'	0°30'
Work position	Any				

** indicative average data that gets influenced by various factors such as the stroke, the type of motor, the cylinder version, etc ...

N.B.: On request available with:

- piston rod in stainless steel (Ø32, Ø50 in AISI 316; Ø63, Ø63HD, Ø80, Ø100 in AISI 304), with limitations to the maximum stroke;
- head-sleeve fixing screws in AISI 316 stainless steel;
- lubrication grease compatible with the food industry, certified NSF Cat. H1 (accidental contact with food).

MECHANICAL FEATURES		Ø 32			Ø 50			Ø 63			Ø 63 HD		Ø 80			Ø 100	
Screw pitch (p)	mm	4	12	5	10	16	5	10	20	5	10	5	10	32	10	40	
Screw diameter	mm	12	12	16	16	16	20	20	20	20	20	32	32	32	50	40	
Static axial load (F ₀)*	N	3300			4300			7500			12800		27150			36080	
Dynamic axial load (F)	N	5200	5600	10500	6670	4330	10010	12800	4880	17600	18980	30000	43000	26000	73000	43000	
Calculate mean axial load and the calculate life (see graphs on page A5.10)																	
Maximum number of revs	1/min	4000			3000			2500			2500		2000			3000	2200
Maximum speed (V _{max})	mm/s	267	800	250	500	800	208	417	833	208	417	165	310	1100	500	1500	

* N.B.: Static loads bearable without damage. Useful loads are shown in the diagrams on page A5.12 onwards.

WEIGHTS (ONLY CYLINDER)		Ø 32			Ø 50			Ø 63 - 63 HD			Ø 80			Ø 100	
Screw pitch (p)	mm	4	12	5	10	16	5	10	20	5	10	32	10	40	
Weight at stroke 0	g	896	973	1990	2043	2086	2942	3209	3056	8658	8629	8650	15049	13719	
Additional weight each mm of stroke	g	3.98	3.96	6.64	6.62	6.55	6.25	6.32	6.32	15.6	15.3	16	35.5	26	
Weight of the in-line transmission (without motor)	g	300			900			1100			1700			2900	
Weight of the geared transmission (without motor)	g	1100			2000			3000			6300			8700	
Moving mass at stroke 0 (non-rotating version) Mx	g	270	353	586	629	703	956	1215	1067	3709	3730	3667	6630	6171	
Additional moving mass each mm of stroke	g	1.25			1.84			1.98			4.9			15	9.6

N.B.: You get the total weight of a complete cylinder by adding: weight stroke 0 + stroke [mm] x weight for each mm of stroke + weight of the transmission + weight of the motor.

MASS MOMENTS OF INERTIA

		Ø 32			Ø 50			Ø 63 - 63 HD					
Screw pitch	mm	4	12	5	10	16	5	10	20	5	10	20 (only Ø63)	
Transmission ratio (τ)		1:1	1:1	1:1	1:1	1:1	1:1	1:1	1:1	1:1	1:1	1:1	
J0 at stroke 0	kgmm ²	1.2407	2.4309	5.3455	6.1360	9.1113	12.4043	14.8767	23.5427				
J1 each metre of stroke	kgmm ² /m	12.2592	17.8468	35.2305	38.5264	49.1936	86.2990	96.6652	116.3671				
J2 each kg of load	kgmm ² /kg	0.4053	3.6476	0.6333	2.5332	6.4849	0.6333	2.5332	10.1327				
J3 in-line transmission	kgmm ²	5.2			5.2			36.2					
J3 geared transmission	kgmm ²	53.2			126.5			237.7					

		Ø 80								
Screw pitch	mm	5			10			32		
Transmission ratio (τ)		1:1	1:1.25	1:1	1:1	1:1.25	1:1.5	1:1	1:1.5	1:1.5
J0 at stroke 0	kgmm ²	430			420.3			438.8		
J1 each metre of stroke	kgmm ² /m	688			608			753		
J2 each kg of load	kgmm ² /kg	0.6333			2.5330			25.9382		
J3 in-line transmission	kgmm ²	148.2	-	148.2	-	-	-	148.2	-	-
J3 geared transmission	kgmm ²	1041.7	388.3	1041.7	388.3	1071.6	1071.6	1041.7	1071.6	1071.6

		Ø 100					
Screw pitch	mm	10			40		
Transmission ratio (τ)		1:1	1:2	1:3 ●	1:1	1:2	1:3 ●
J0 at stroke 0	kgmm ²	1357			1042.4		
J1 each metre of stroke	kgmm ² /m	3984			1869.3		
J2 each kg of load	kgmm ² /kg	2.5330			40.5284		
J3 in-line transmission	kgmm ²	327.8	-	594.8	327.8	-	549.8
J3 geared transmission	kgmm ²	1041.7	1161.1	-	1041.7	1161.1	-

● in line with gearbox

The total mass moment of inertia (J_{tot}) reduced for the motor is: J_{tot} = [J1 · Stroke [m] + J2 · (Load [kg] + Mx [kg]) + J0] · τ² + J3

Mx is defined in the weight table.

CALCULATION OF MEAN AXIAL LOAD F_m AND VERIFICATION

Peak axial load in a work cycle must not exceed the static axial load F_o . The peak value is usually achieved during upward acceleration in vertical installation. Exceeding this value leads to greater wear and hence shorter life of the recirculating ball screw.

Mean axial load F_m

$$F_m = \sqrt[3]{\sum F_x^3 \times \frac{V_x}{V_m} \times \frac{q}{100}} =$$

$$F_m = \sqrt[3]{F_{x1}^3 \times \frac{V_{x1}}{V_m} \times \frac{q_1}{100} + F_{x2}^3 \times \frac{V_{x2}}{V_m} \times \frac{q_2}{100} + F_{x3}^3 \times \frac{V_{x3}}{V_m} \times \frac{q_3}{100} + \dots}$$

- F_x = Axial load at stage x
- F_m = Mean axial load during extension
- F_o = Static axial load
- q = Time segment
- V_x = Speed in the phase x
- V_m = Average speed

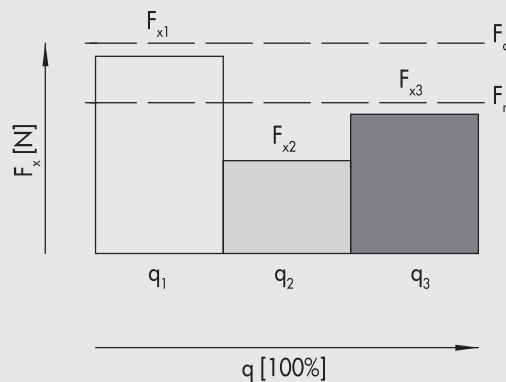

The mean axial load must not exceed the dynamic axial load: $F_m \leq F$
 The graphs on page A5.10 show screw life as a function of F_m

BARREL CROSS SECTION

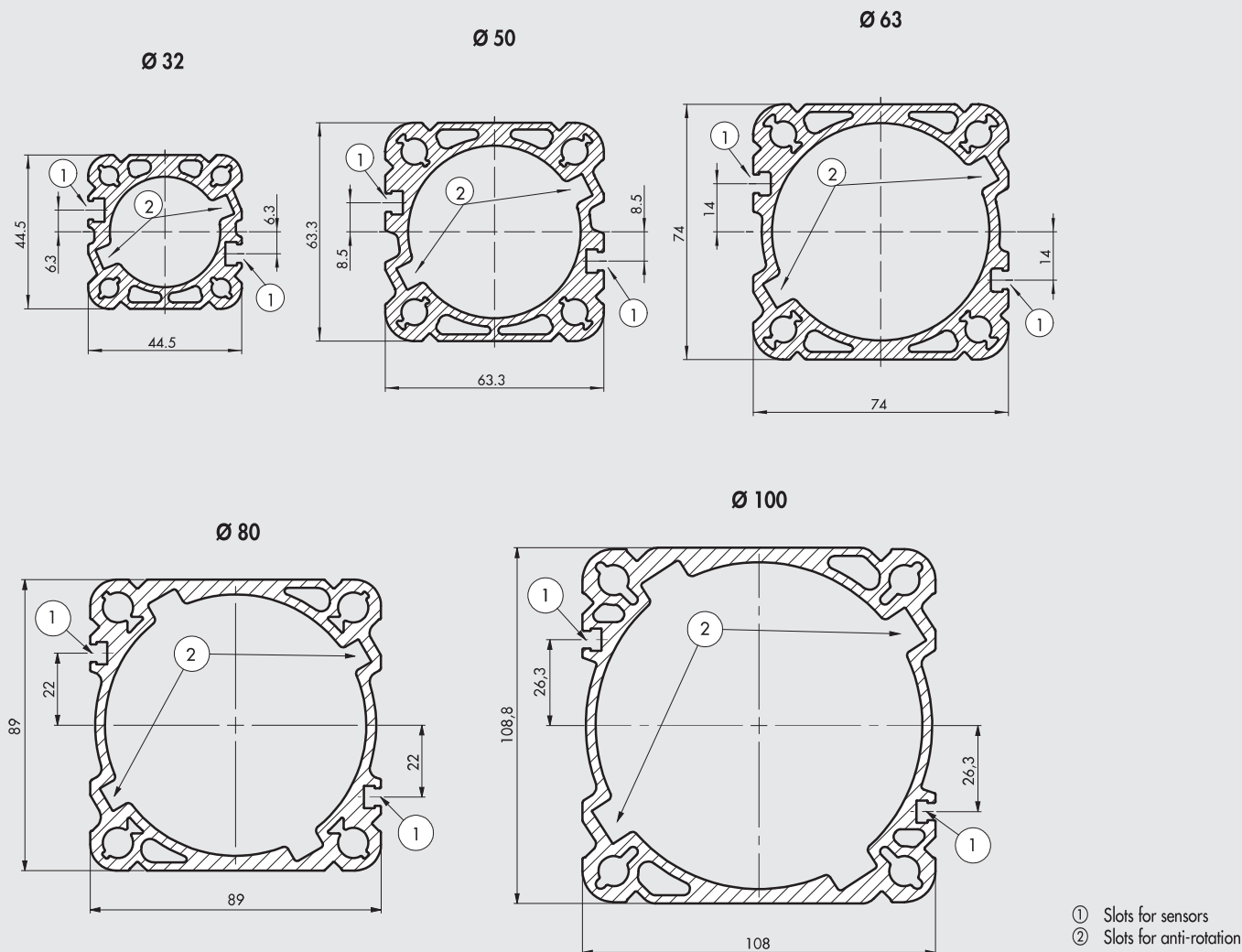

COMPONENTS

CYLINDER

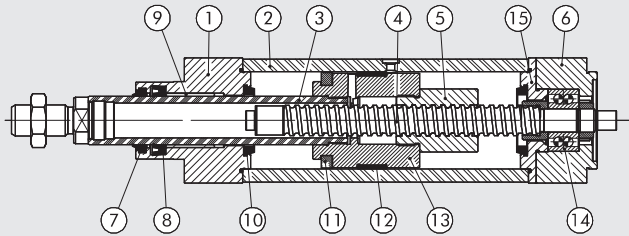

CYLINDER WITH IN-LINE MOTOR

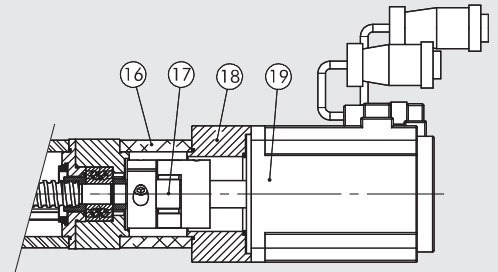

CYLINDER WITH GEARED MOTOR

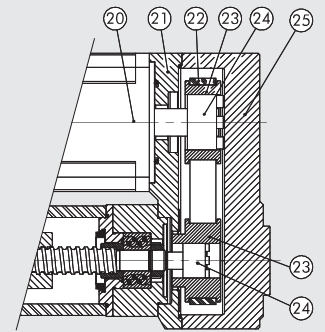

CYLINDER WITH MOTOR AND GEARBOX

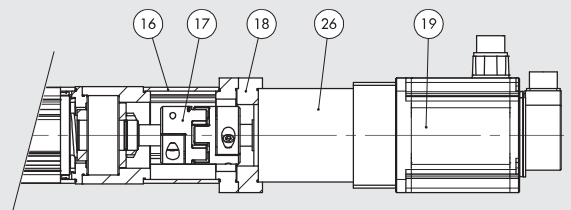

- ① FRONT CYLINDER HEAD: anodized aluminium
- ② BARREL: extruded and anodized aluminium alloy
- ③ PISTON ROD: grinded chromed steel
- ④ WORM SCREW: hardened steel
- ⑤ BALL SCREW NUT: steel
- ⑥ REAR CYLINDER HEAD: anodized aluminium
- ⑦ WIPER RING: polyurethane
- ⑧ PISTON ROD GASKET: NBR (IP55/ IP65 version only)
- ⑨ GUIDE BUSHING: steel strip with bronze and PTFE insert
- ⑩ BUFFER: technopolymer
- ⑪ MAGNET: plastoferrite
- ⑫ GUIDE STRIP: self-lubricated calibrated technopolymer
- ⑬ PISTON: aluminium
- ⑭ BEARING: oblique with two ball rings
- ⑮ BEARING LOCKING RING: anodized aluminium
- ⑯ BELL: extruded and anodized aluminium alloy
- ⑰ COUPLING
- ⑱ ADAPTOR PLATE: anodized aluminium
- ⑲ ELECTRIC MOTOR
- ⑳ ELECTRIC MOTOR
- ㉑ TRANSMISSION PLATE: anodized aluminium
- ㉒ DRIVE BELT
- ㉓ PULLEY: steel
- ㉔ SHRINK DISC
- ㉕ COVER: anodized aluminium
- ㉖ PLANETARY GEARBOX

PEAK LOADS

The following load conditions applied to the piston rod must be met.

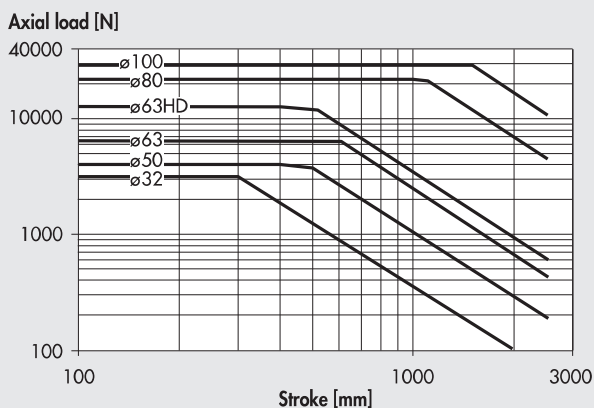

CRITICAL VELOCITY

The two variables (stroke and linear speed) must meet the conditions in the graph below, otherwise resonance could be generated and affect the system.

Ø 32

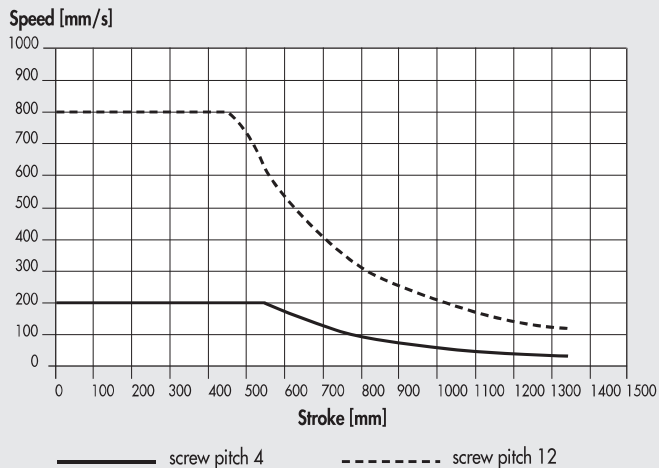

Ø 50

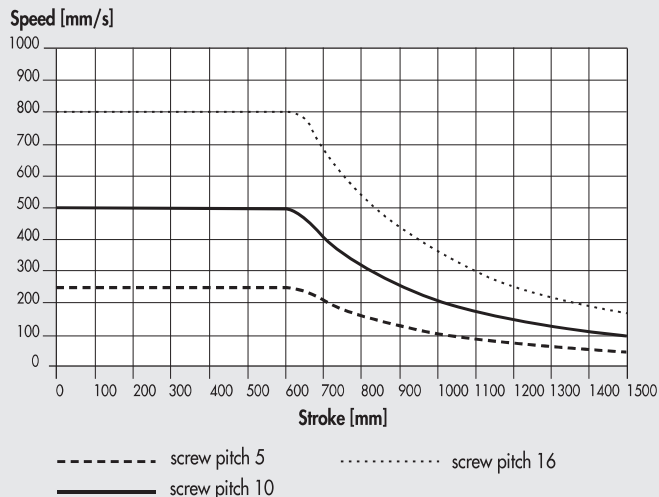

Ø 63 - Ø 63 HD

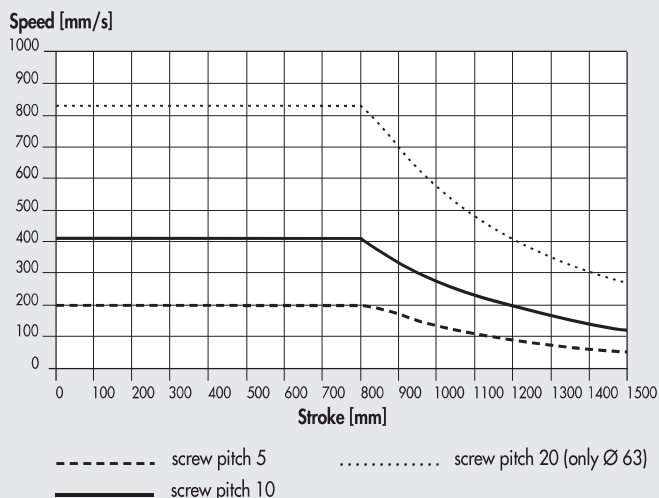

Ø 80

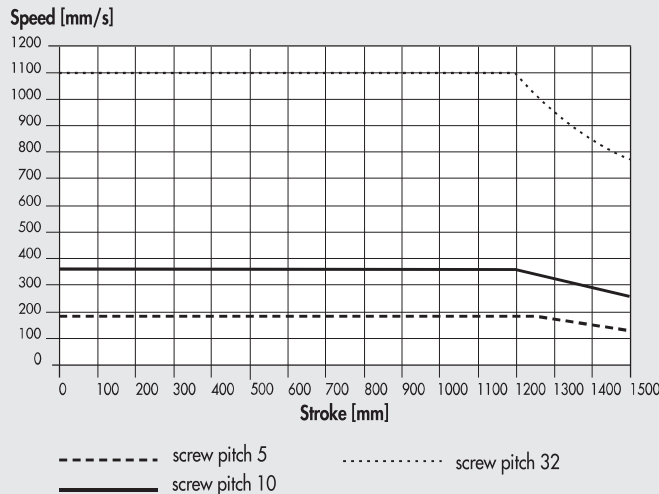

Ø 100

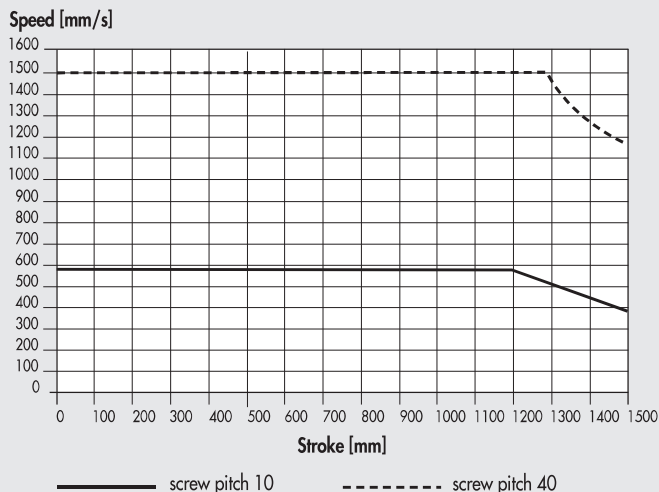

MAXIMUM RADIAL LOADS ON PISTON ROD

Radial loads [N]

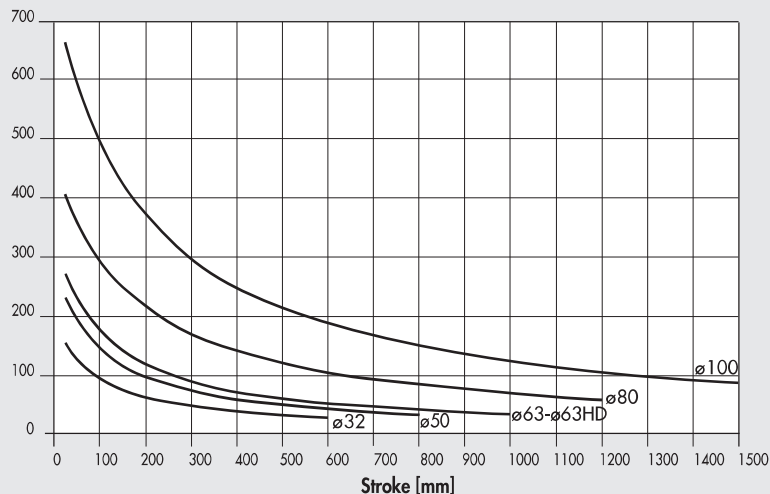

Radial loads can be applied to the piston rod. They must not exceed the values in the adjacent chart, otherwise the guides on the rod and piston will be subjected to excessive wear.

PISTON ROD SPEED DEPENDING ON THE NUMBER OF SCREW TURNS

SCREW PITCH	TRANSMISSION RATIO	K (n/V)
4	1:1	15
5	1:1	12
	1:1.25	15
10	1:1	6
	1:1.25	7.5
	1:1.5	9
	1:2	12
	1:3	18
12	1:1	5
16	1:1	3.75
20	1:1	3
32	1:1	1.87
	1:1.5	2.81
40	1:1	1.5
	1:2	3
	1:3	4.5

The table shows the direct correspondence between the number of turns (1/min) and the translation speed of the stem (mm/s). In any case all the other conditions and limitations of each specific cylinder will have to be complied.

Example:

V = 100 mm/s
pitch = 10
transmission ratio = 1:1.5
K = 9
n = V x K = 900 rpm

DRIVE TORQUE AS A FUNCTION OF THE AXIAL LOAD APPLIED TO THE PISTON ROD

SCREW PITCH	TRANSMISSION RATIO	h (C/F)
4	1:1	0.0008
5	1:1	0.0010
	1:1.25	0.0008
10	1:1	0.0020
	1:1.25	0.0016
	1:1.5	0.0013
	1:2	0.0010
	1:3	0.0007
12	1:1	0.0024
16	1:1	0.0032
20	1:1	0.0040
32	1:1	0.0064
	1:1.5	0.0043
40	1:1	0.0080
	1:2	0.0040
	1:3	0.0027

The friction generated in the mechanical system is taken into account.

Example:

F = 1000 N
pitch = 10
transmission ratio = 1:1.5
h = 0.0013
C = F x h = 1.3 Nm

LIFE CHARACTERISTICS AS A FUNCTION OF THE MEAN AXIAL LOAD

Life characteristics can vary considerably from those indicated in the graphs due to different operating conditions (radial loads, temperature, lubrication status, etc.).

Ø 32

Mean axial load [N]

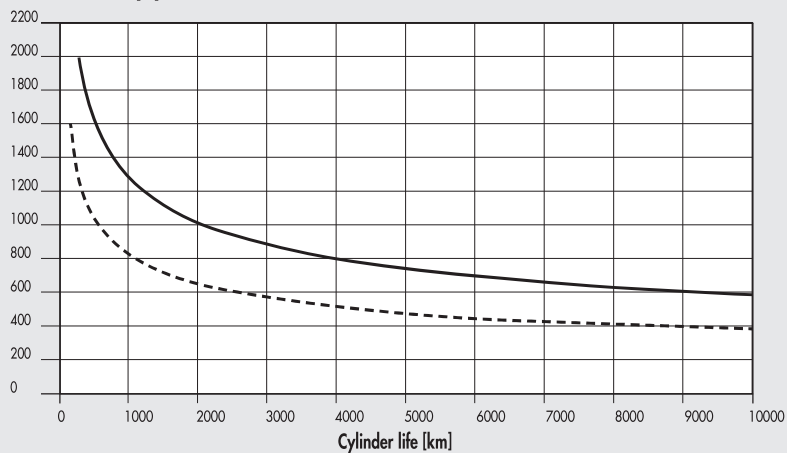

--- screw pitch 4
 — screw pitch 12

Ø 50

Mean axial load [N]

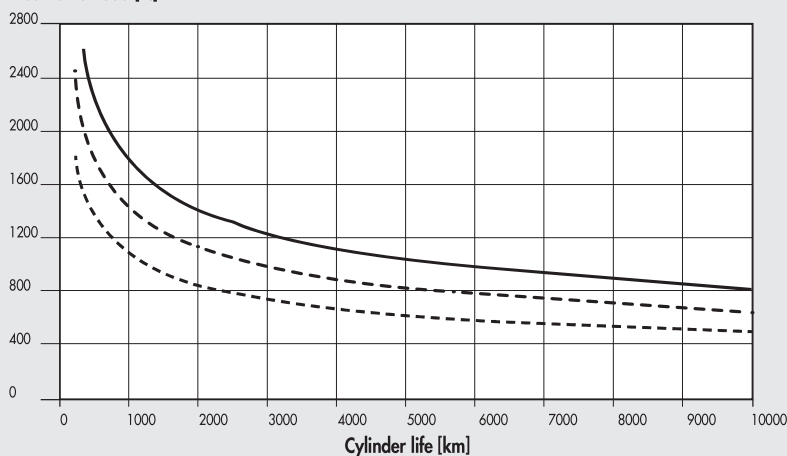

— screw pitch 5
 --- screw pitch 10
 - · - screw pitch 16

Ø 63 - Ø 63 HD

Mean axial load [N]

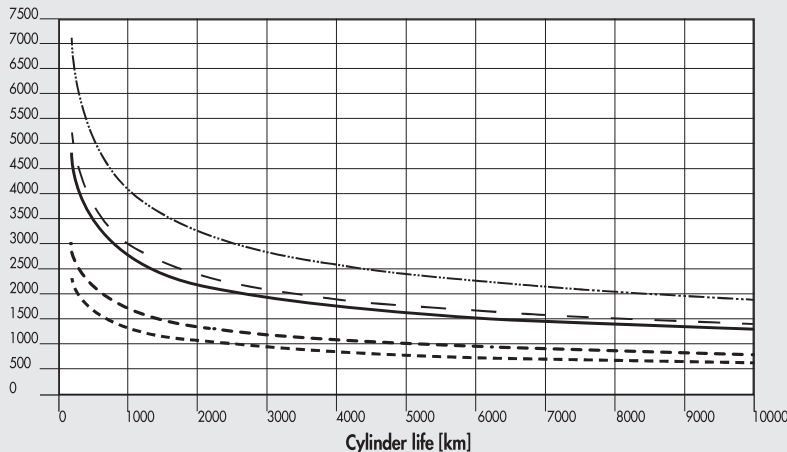

· - · screw pitch 5
 — screw pitch 10
 --- screw pitch 20
 - - - screw pitch 5 HD
 - · - screw pitch 10 HD

Ø 80

Mean axial load [N]

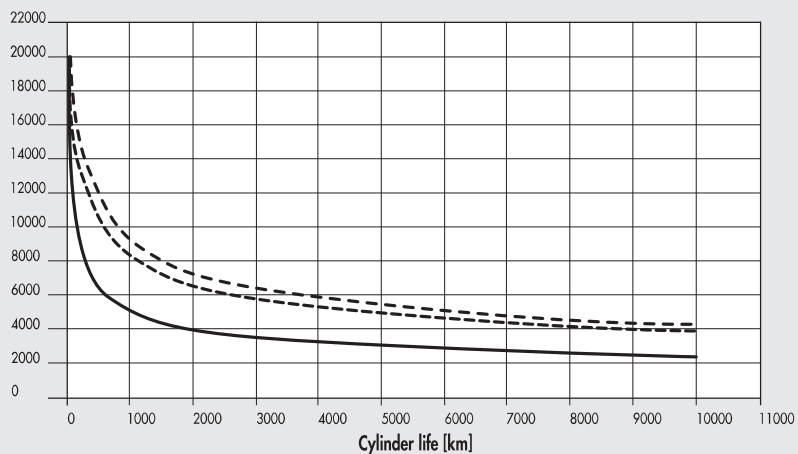

- screw pitch 5
- - - screw pitch 10
- · - · screw pitch 32

Ø 100

Mean axial load [N]

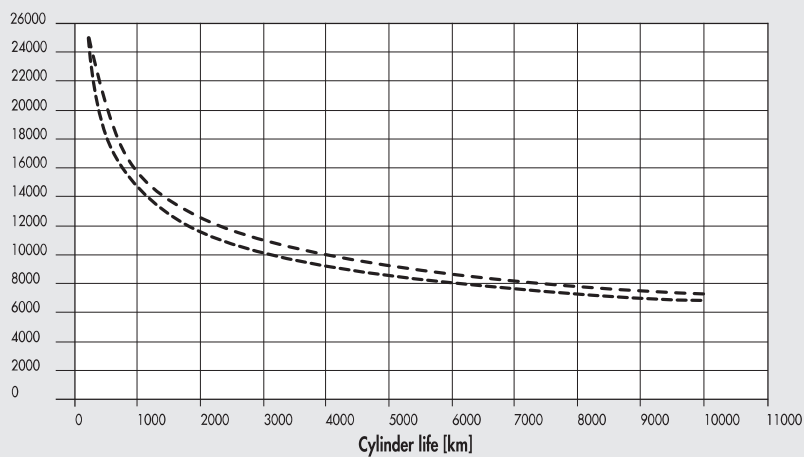

- - - screw pitch 10
- · - · screw pitch 40

NOTES

AXIAL LOAD CURVES AS A FUNCTION OF SPEED (CYLINDER COMPLETE WITH MOTOR AND DRIVE)

N.B.: The obtainable load values already take the efficiency of the system into account. For STEPPING motors, with the motor off, the drive current is automatically reduced by 50% to prevent overheating. Consequently, available axial load with the motor stopped is also reduced by 50%.

Ø 32 with pitch 4 screw, STEPPING motors and motor 1 STEPPING with BRAKE

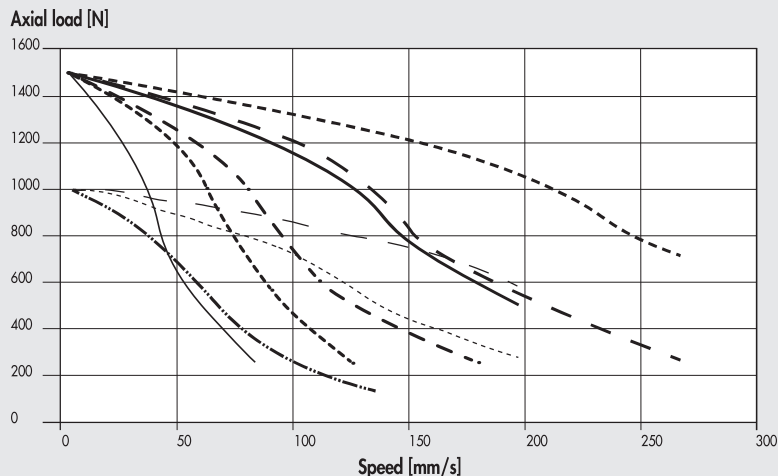

- 37M1110000 (24VDC)
- 37M1110000 (48VDC)
- 37M1110000 (75VDC)
- 37M1120000 (24VDC) or 37M5120000 (with brake, 24VDC)
- 37M1120000 (48VDC) or 37M5120000 (with brake, 48VDC)
- 37M1120000 (75VDC) or 37M5120000 (with brake, 75VDC)
- 37M1120001 (24VDC)
- 37M1120001 (48VDC)
- 37M1120001 (75VDC)

Ø 32 with pitch 4 screw, STEPPING motors with BRAKE + ENCODER

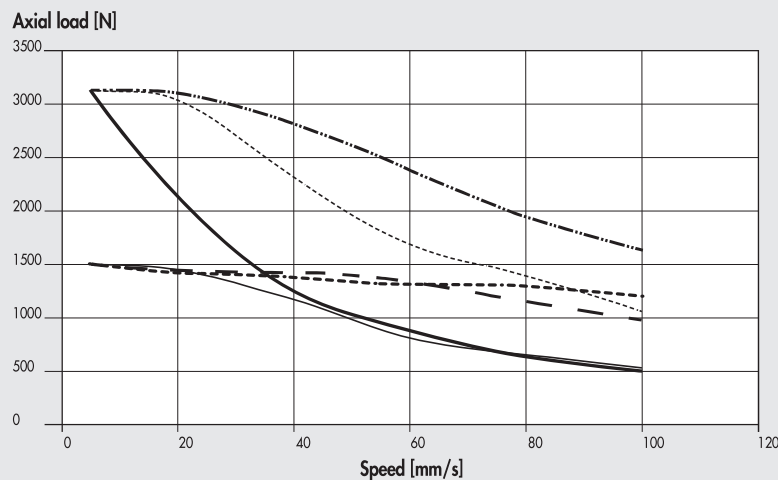

- 37M3220000 (24VDC)
- 37M3220000 (48VDC)
- 37M3220000 (75VDC)
- 37M3230000 (24VDC)
- 37M3230000 (48VDC)
- 37M3230000 (75VDC)

Ø 32 with pitch 12 screw, STEPPING motors and motor 1 STEPPING with BRAKE

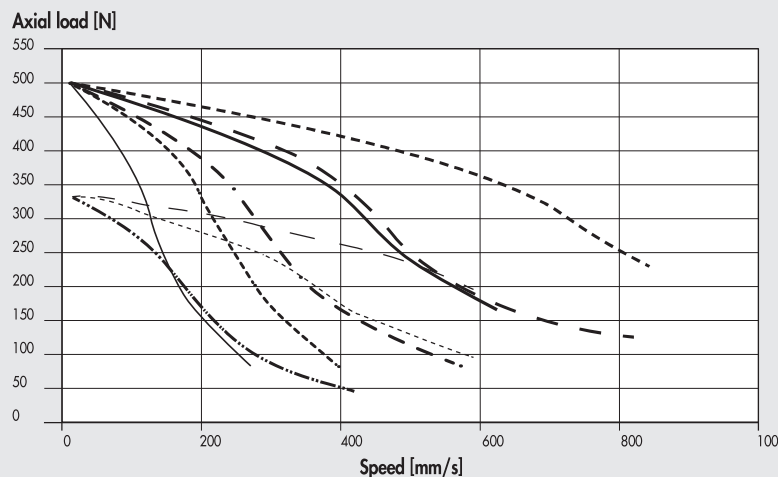

- 37M1110000 (24VDC)
- 37M1110000 (48VDC)
- 37M1110000 (75VDC)
- 37M1120000 (24VDC) or 37M5120000 (with brake, 24VDC)
- 37M1120000 (48VDC) or 37M5120000 (with brake, 48VDC)
- 37M1120000 (75VDC) or 37M5120000 (with brake, 75VDC)
- 37M1120001 (24VDC)
- 37M1120001 (48VDC)
- 37M1120001 (75VDC)

Ø 32 with pitch 12 screw, STEPPING motors with BRAKE + ENCODER

Axial load [N]

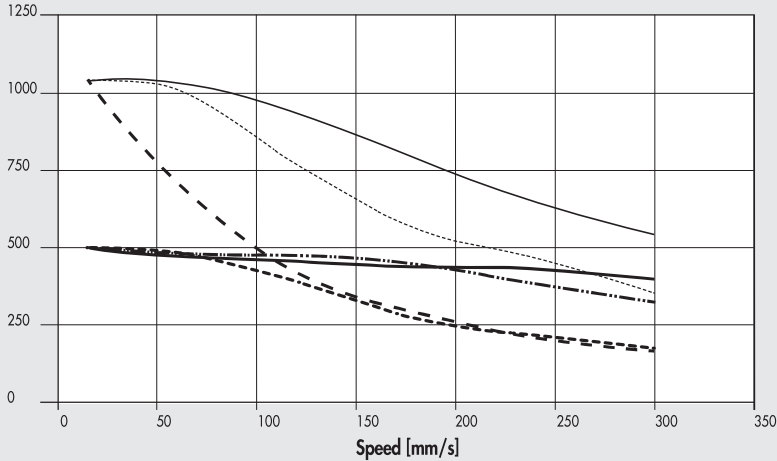

- 37M3220000 (24VDC)
- 37M3220000 (48VDC)
- 37M3220000 (75VDC)
- 37M3230000 (24VDC)
- 37M3230000 (48VDC)
- 37M3230000 (75VDC)

Ø 50 with pitch 5 screw, STEPPING motors

Axial load [N]

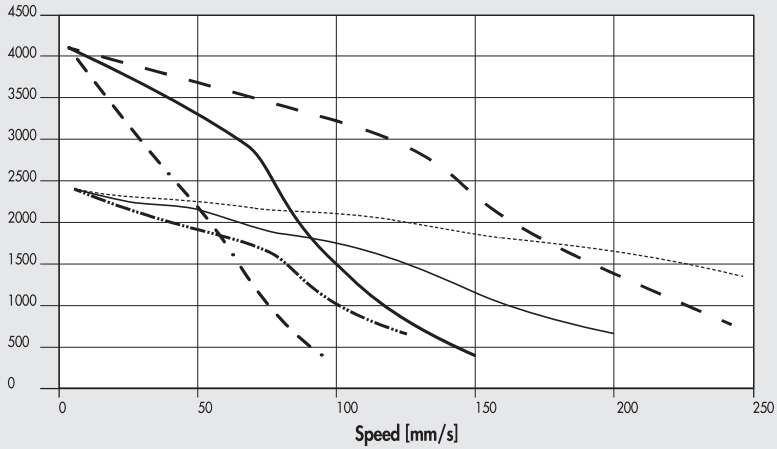

- 37M1430000 (48VDC)
- 37M1430000 (75VDC)
- 37M1430000 (1140VDC)
- 37M1440000 (48VDC)
- 37M1440000 (75VDC)
- 37M1440000 (1140VDC)

Ø 50 with pitch 5 screw, STEPPING motors with BRAKE + ENCODER

Axial load [N]

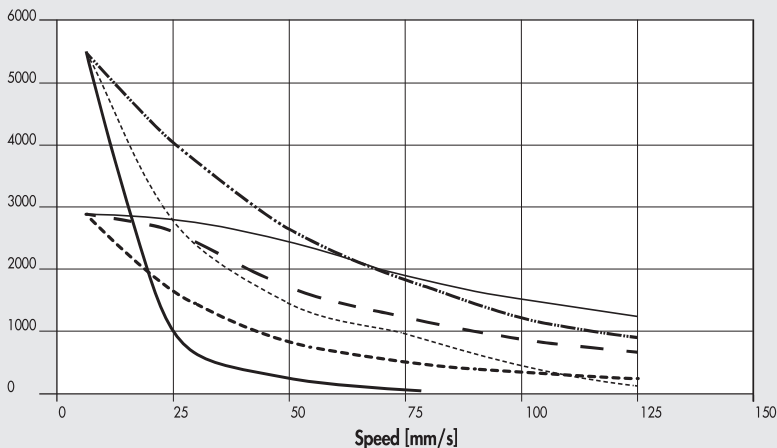

- 37M3430000 (24VDC)
- 37M3430000 (48VDC)
- 37M3430000 (75VDC)
- 37M3460000 (24VDC)
- 37M3460000 (48VDC)
- 37M3460000 (75VDC)

Ø 50 with pitch 10 screw, STEPPING motors

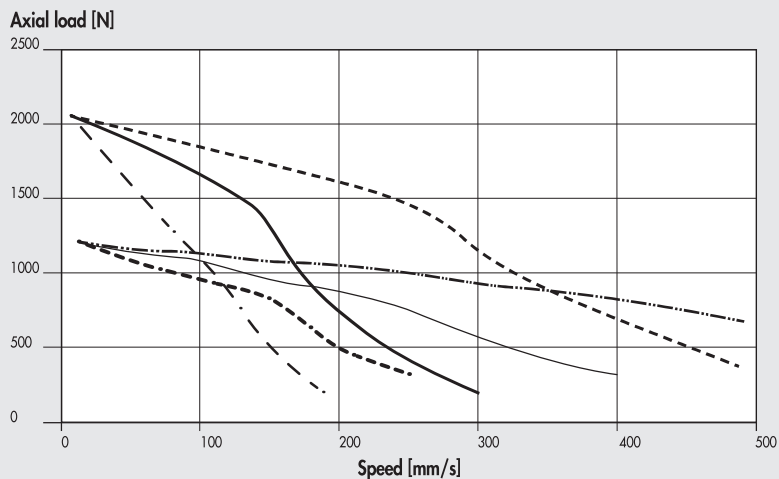

- 37M1430000 (48VDC)
- 37M1430000 (75VDC)
- 37M1430000 (140VDC)
- - - - 37M1440000 (48VDC)
- 37M1440000 (75VDC)
- 37M1440000 (140VDC)

Ø 50 with pitch 10 screw, STEPPING motors with BRAKE + ENCODER

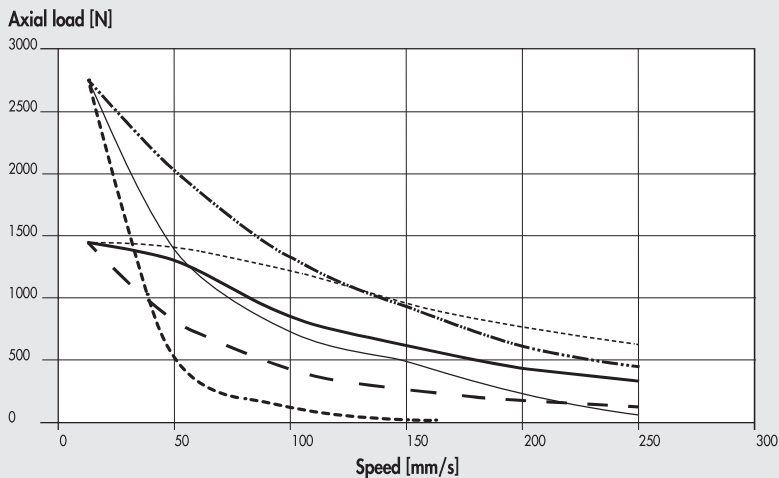

- - - - 37M3430000 (24VDC)
- 37M3430000 (48VDC)
- 37M3430000 (75VDC)
- 37M3460000 (24VDC)
- 37M3460000 (48VDC)
- 37M3460000 (75VDC)

Ø 50 with pitch 16 screw, STEPPING motors

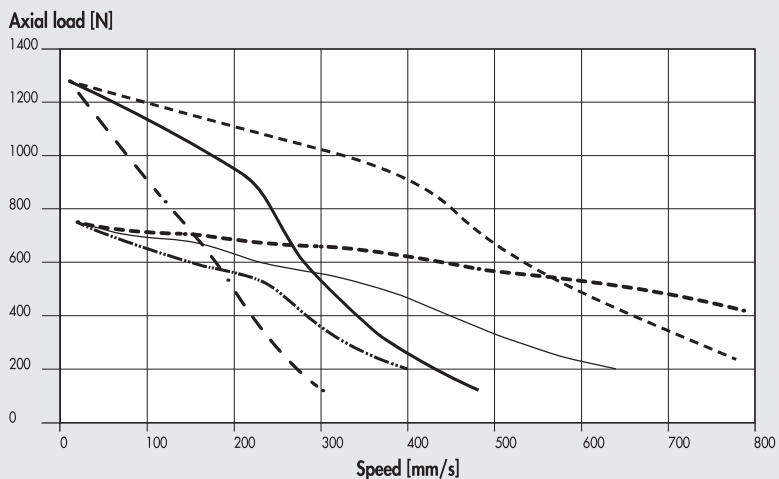

- 37M1430000 (48VDC)
- 37M1430000 (75VDC)
- 37M1430000 (140VDC)
- - - - 37M1440000 (48VDC)
- 37M1440000 (75VDC)
- 37M1440000 (140VDC)

Ø 50 with pitch 16 screw, STEPPING motors with BRAKE + ENCODER

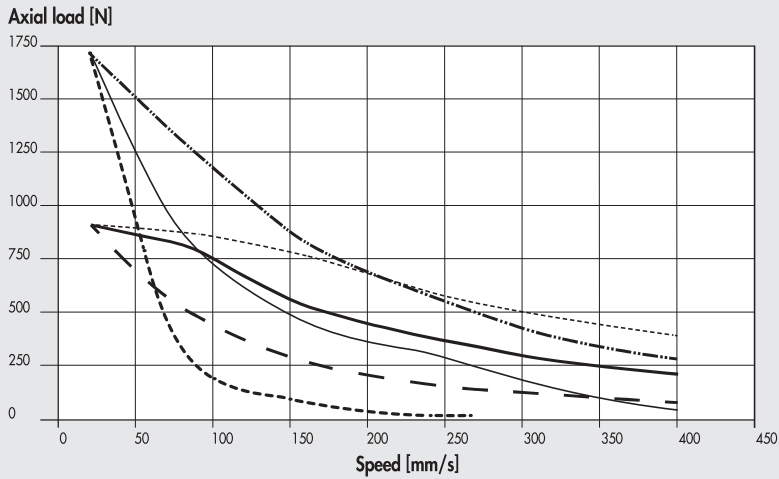

- 37M3430000 (24VDC)
- 37M3430000 (48VDC)
- · · 37M3430000 (75VDC)
- - - 37M3460000 (24VDC)
- 37M3460000 (48VDC)
- · · 37M3460000 (75VDC)

Ø 63 with pitch 5 screw, STEPPING motors

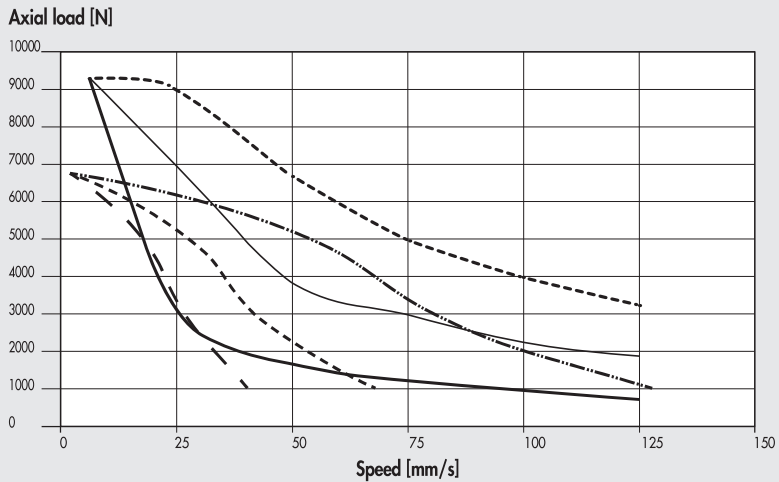

- 37M1450000 (48VDC)
- - - 37M1450000 (75VDC)
- · · 37M1450000 (140VDC)
- 37M1470000 (24VDC)
- 37M1470000 (48VDC)
- - - 37M1470000 (75VDC)

Ø 63 with pitch 5 screw, STEPPING motors with BRAKE + ENCODER

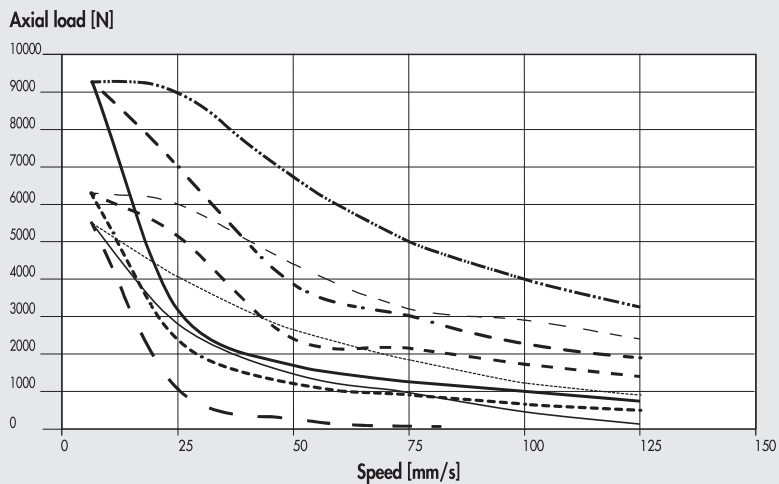

- · · 37M3450000 (24VDC)
- - - 37M3450000 (48VDC)
- - - 37M3450000 (75VDC)
- - - 37M3460000 (24VDC)
- 37M3460000 (48VDC)
- · · 37M3460000 (75VDC)
- 37M3470000 (24VDC)
- - - 37M3470000 (48VDC)
- · · 37M3470000 (75VDC)

Ø 63 with pitch 10 screw, STEPPING motors

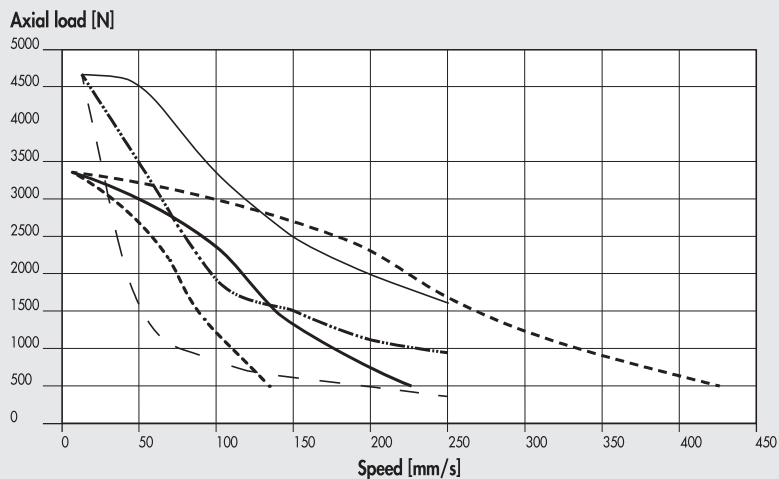

- 37M1450000 (48VDC)
- 37M1450000 (75VDC)
- 37M1450000 (140VDC)
- 37M1470000 (24VDC)
- 37M1470000 (48VDC)
- 37M1470000 (75VDC)

Ø 63 with pitch 10 screw, STEPPING motors with BRAKE + ENCODER

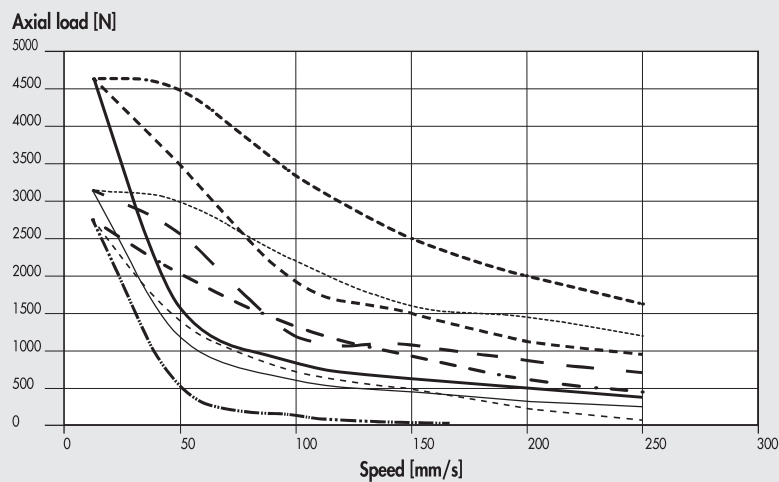

- 37M3450000 (24VDC)
- 37M3450000 (48VDC)
- 37M3450000 (75VDC)
- 37M3460000 (24VDC)
- 37M3460000 (48VDC)
- 37M3460000 (75VDC)
- 37M3470000 (24VDC)
- 37M3470000 (48VDC)
- 37M3470000 (75VDC)

Ø 63 with pitch 20 screw, STEPPING motors

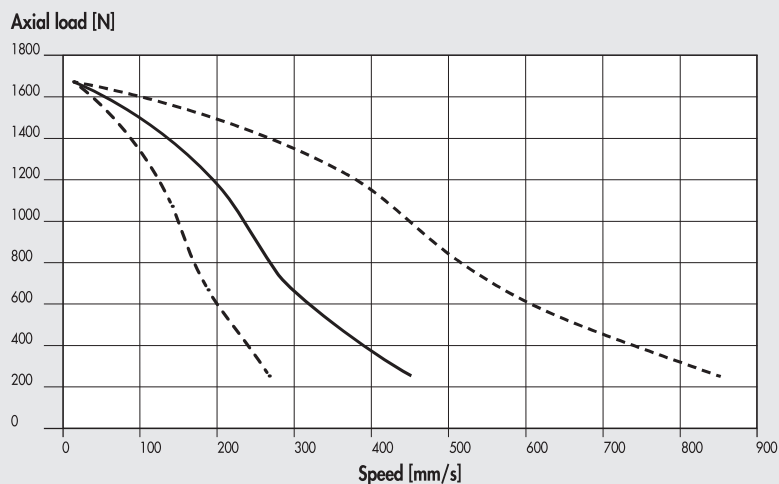

- 37M1450000 (48VDC)
- 37M1450000 (75VDC)
- 37M1450000 (140VDC)

Ø 63 with pitch 20 screw, STEPPING motors with BRAKE + ENCODER

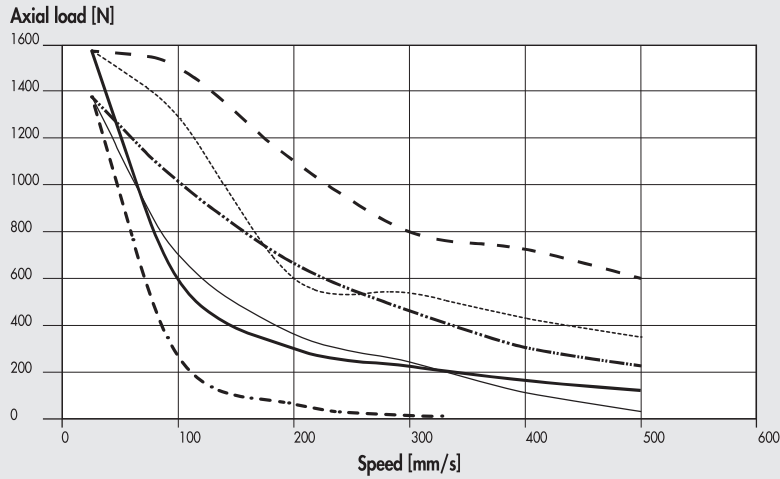

- 37M3450000 (24VDC)
- 37M3450000 (48VDC)
- - - 37M3450000 (75VDC)
- · - · 37M3460000 (24VDC)
- 37M3460000 (48VDC)
- · - · 37M3460000 (75VDC)

Ø 80 with pitch 5 screw, STEPPING motors

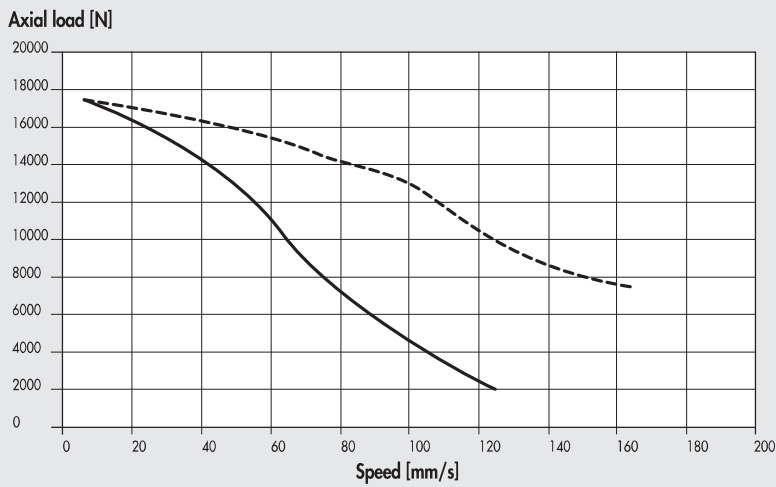

- - - 37M1890000 + 37D1362001 (230VAC)
- 37M1890000 + 37D1362001 (115VAC)

Ø 80 with pitch 10 screw, STEPPING motors

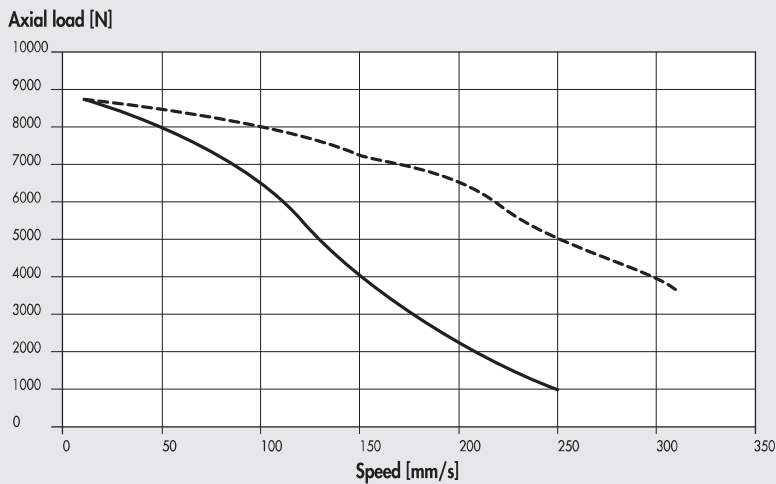

- - - 37M1890000 + 37D1362001 (230VAC)
- 37M1890000 + 37D1362001 (115VAC)

Ø 80 with pitch 32 screw, STEPPING motors

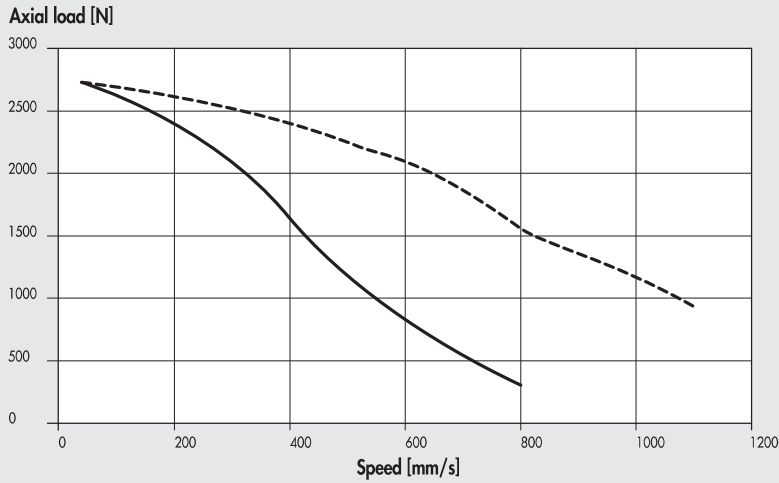

----- 37M1890000 + 37D1362001 (230VAC)
 _____ 37M1890000 + 37D1362001 (115VAC)

Ø 100 with pitch 10 screw, STEPPING motors

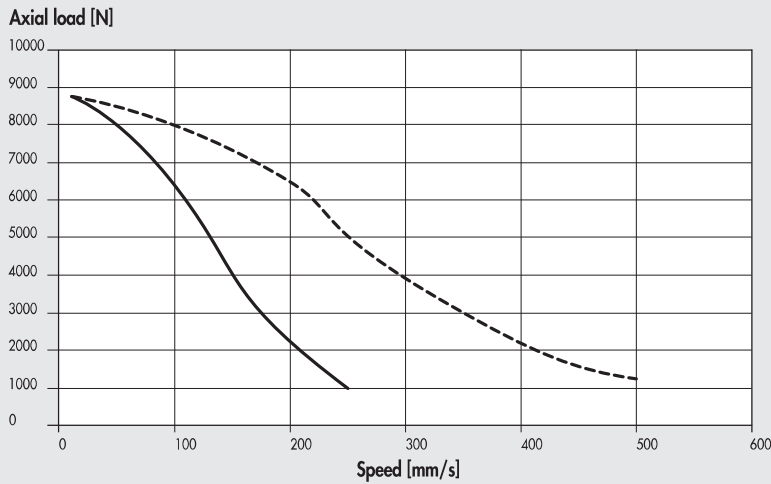

----- 37M1890000 + 37D1362001 (230VAC)
 _____ 37M1890000 + 37D1362001 (115VAC)

Ø 100 with pitch 40 screw, STEPPING motors

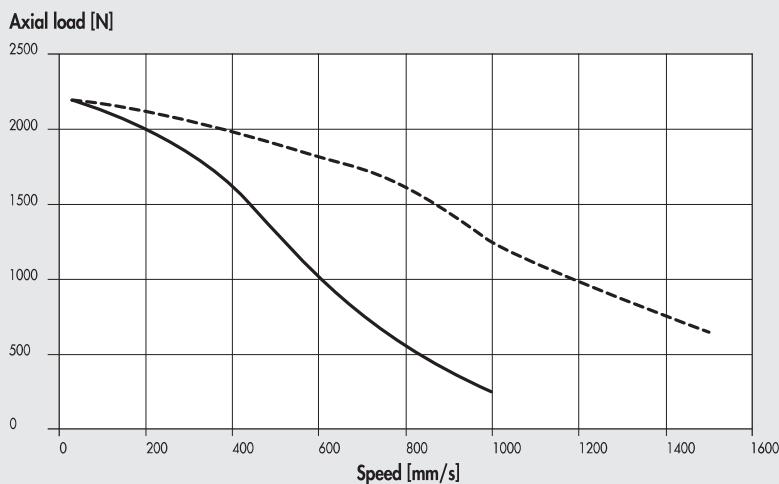

----- 37M1890000 + 37D1362001 (230VAC)
 _____ 37M1890000 + 37D1362001 (115VAC)

Ø 32 with pitch 4 screw, BRUSHLESS motors and BRUSHLESS motors with BRAKE

Axial load [N]

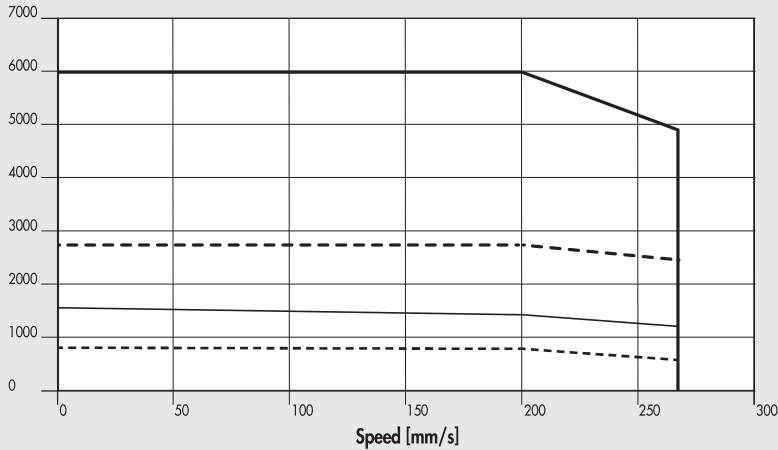

- Nominal 37M2200000 or 37M4200000 (with brake) + 37D2400008 (200W)
- _____ Nominal 37M2220000 or 37M4220000 (with brake) + 37D2400008 (400W)
- Maximum 37M2200000 or 37M4200000 (with brake) + 37D2400008 (200W)
- _____ Maximum 37M2220000 or 37M4220000 (with brake) + 37D2400008 (400W)

Ø 32 with pitch 12 screw, BRUSHLESS motors and BRUSHLESS motors with BRAKE

Axial load [N]

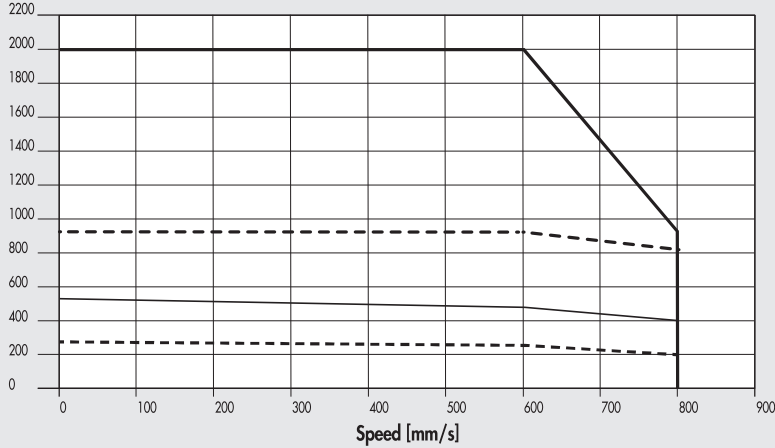

- Nominal 37M2200000 or 37M4200000 (with brake) + 37D2400008 (200W)
- _____ Nominal 37M2220000 or 37M4220000 (with brake) + 37D2400008 (400W)
- Maximum 37M2200000 or 37M4200000 (with brake) + 37D2400008 (200W)
- _____ Maximum 37M2220000 or 37M4220000 (with brake) + 37D2400008 (400W)

Ø 50 with pitch 5 screw, BRUSHLESS motors and BRUSHLESS motors with BRAKE

Axial load [N]

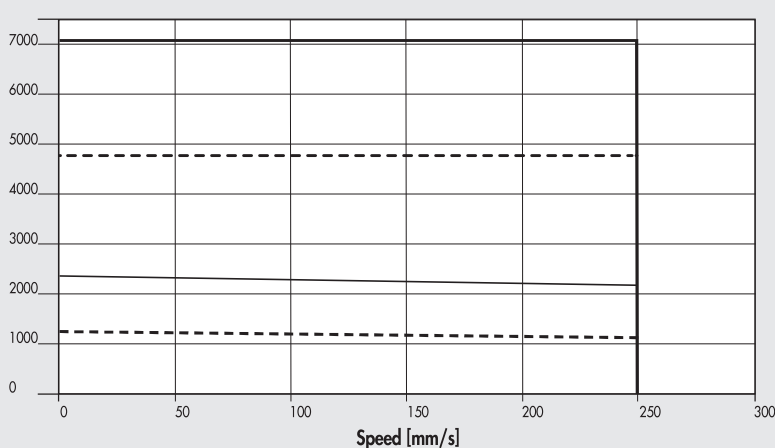

- Nominal 37M2220000 or 37M4220000 (with brake) + 37D2400008 (400W)
- _____ Nominal 37M2330000 or 37M4330000 (with brake) + 37D2400008 (750W)
- Maximum 37M2220000 or 37M4220000 (with brake) + 37D2400008 (400W)
- _____ Maximum 37M2330000 or 37M4330000 (with brake) + 37D2400008 (750W)

Ø 50 with pitch 10 screw, BRUSHLESS motors and BRUSHLESS motors with BRAKE

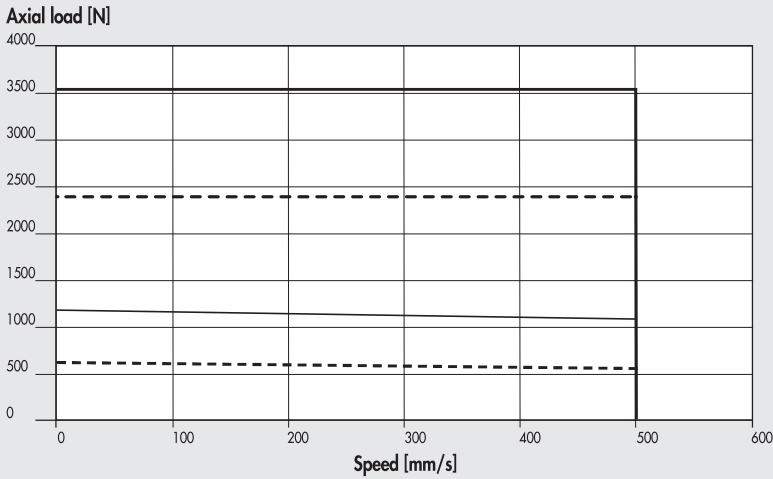

- Nominal 37M2220000
or 37M4220000 (with brake)
+ 37D2400008 (400W)
- Nominal 37M2330000
or 37M4330000 (with brake)
+ 37D2400008 (750W)
- Maximum 37M2220000
or 37M4220000 (with brake)
+ 37D2400008 (400W)
- Maximum 37M2330000
or 37M4330000 (with brake)
+ 37D2400008 (750W)

Ø 50 with pitch 16 screw, BRUSHLESS motors and BRUSHLESS motors with BRAKE

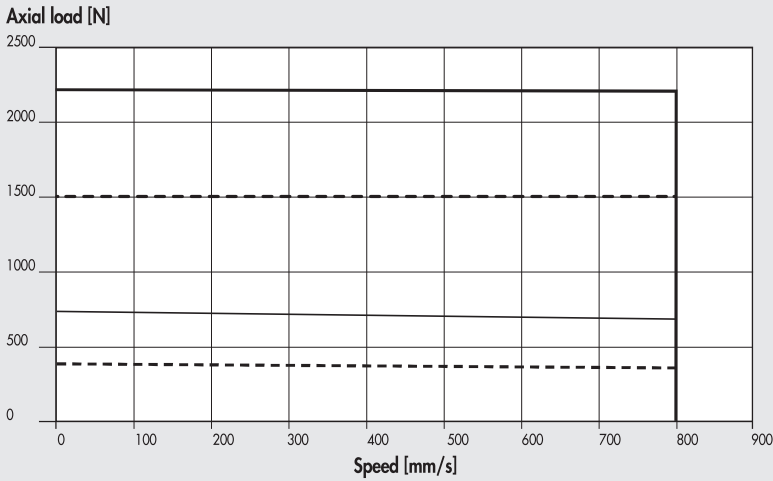

- Nominal 37M2220000
or 37M4220000 (with brake)
+ 37D2400008 (400W)
- Nominal 37M2330000
or 37M4330000 (with brake)
+ 37D2400008 (750W)
- Maximum 37M2220000
or 37M4220000 (with brake)
+ 37D2400008 (400W)
- Maximum 37M2330000
or 37M4330000 (with brake)
+ 37D2400008 (750W)

Ø 63 - Ø 63 HD with pitch 5 screw, BRUSHLESS motors and BRUSHLESS motors with BRAKE (750 W)

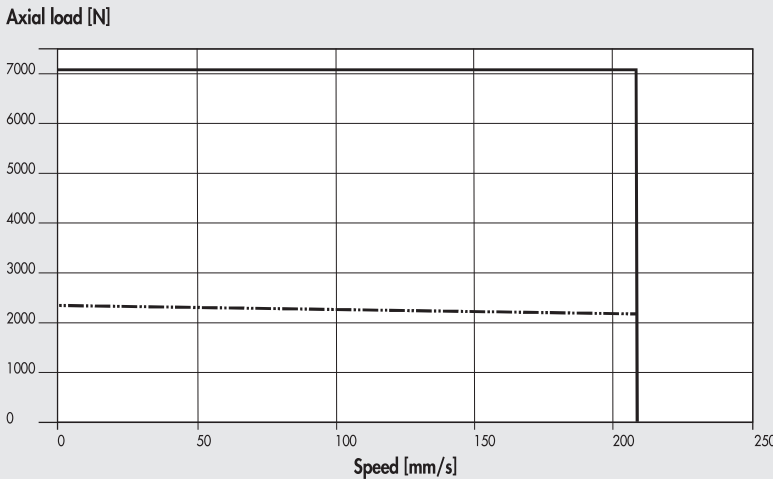

- Nominal 37M2330000
or 37M4330000 (with brake)
+ 37D2400008 (750W)
- Maximum 37M2330000
or 37M4330000 (with brake)
+ 37D2400008 (750W)

Ø 63 HD with pitch 5 screw, BRUSHLESS motors and BRUSHLESS motors with BRAKE (1000 W)

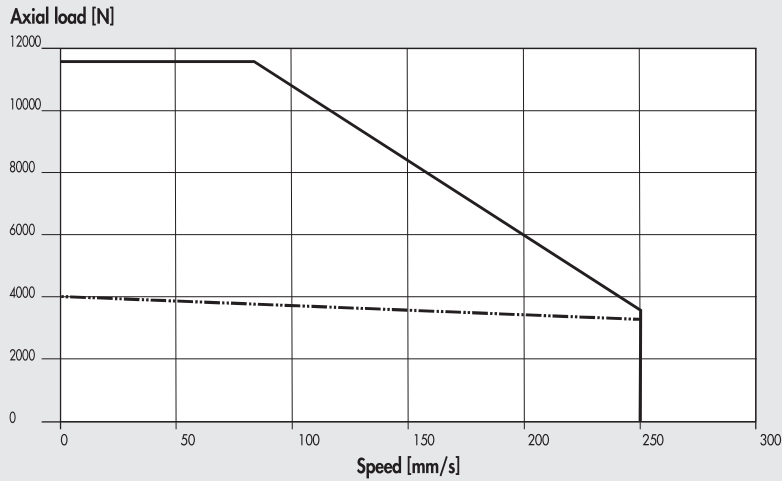

- Nominal 37M2540000 or 37M4540000 (with brake) + 37D2400008 (1000W)
- Maximum 37M2540000 or 37M4540000 (with brake) + 37D2400008 (1000W)

Ø 63 - Ø 63 HD with pitch 10 screw, BRUSHLESS motors and BRUSHLESS motors with BRAKE (750 W)

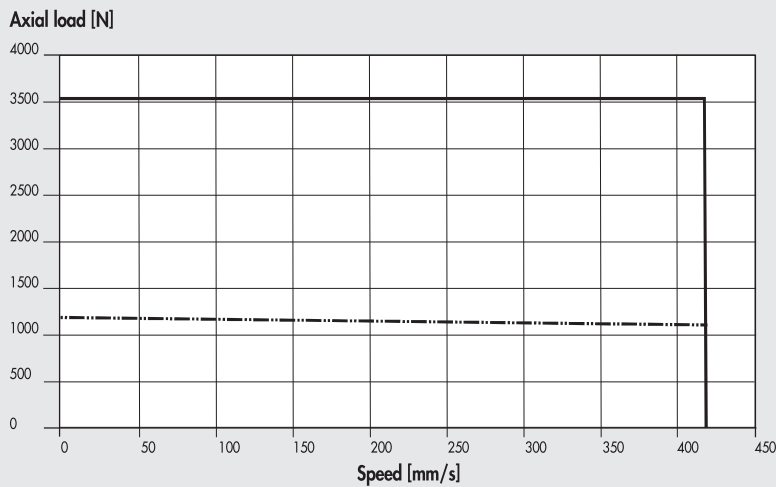

- Nominal 37M2330000 or 37M4330000 (with brake) + 37D2400008 (750W)
- Maximum 37M2330000 or 37M4330000 (with brake) + 37D2400008 (750W)

Ø 63 HD with pitch 10 screw, BRUSHLESS motors and BRUSHLESS motors with BRAKE (1000 W)

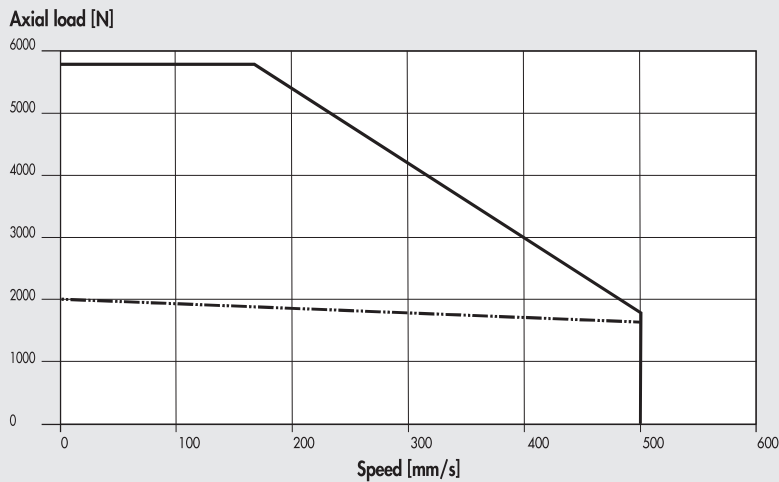

- Nominal 37M2540000 or 37M4540000 (with brake) + 37D2400008 (1000W)
- Maximum 37M2540000 or 37M4540000 (with brake) + 37D2400008 (1000W)

Ø 63 with pitch 20 screw, BRUSHLESS motors and BRUSHLESS motors with BRAKE

Axial load [N]

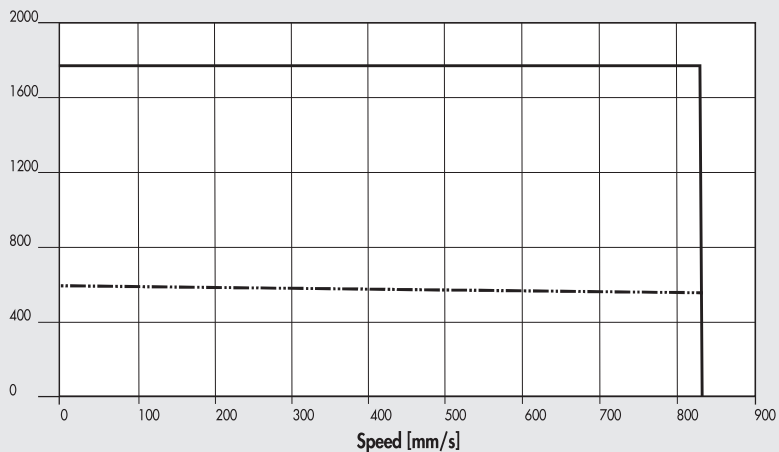

..... Nominal 37M2330000
or 37M4330000 (with brake)
+ 37D2400008 (750W)

———— Maximum 37M2330000
or 37M4330000 (with brake)
+ 37D2400008 (750W)

Ø 80 with pitch 5 screw, BRUSHLESS motors and BRUSHLESS motors with BRAKE (1000W)

Axial load [N]

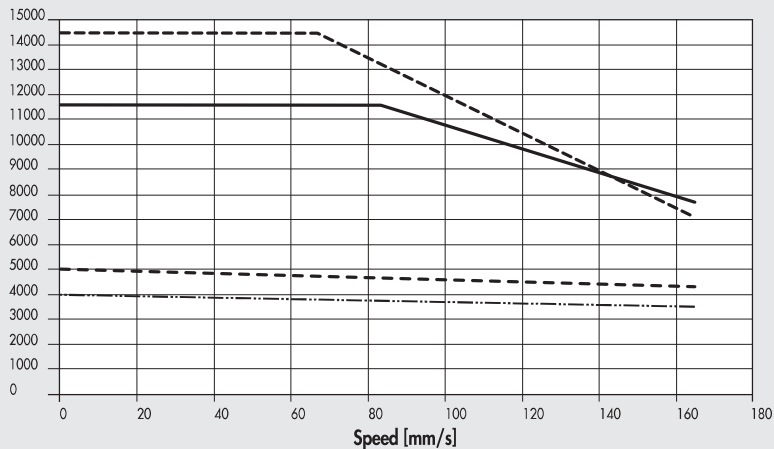

———— Maximum 37M2540000
or 37M4540000 (with brake)
+ 37D2400008 (1000W) in-line version (1:1)

..... Nominal 37M2540000
or 37M4540000 (with brake)
+ 37D2400008 (1000W) in-line version (1:1)

----- Maximum 37M2540000
or 37M4540000 (with brake)
+ 37D2400008 (1000W) geared version (1:1.25)

----- Nominal 37M2540000
or 37M4540000 (with brake)
+ 37D2400008 (1000W) geared version (1:1.25)

Ø 80 with pitch 10 screw, BRUSHLESS motors and BRUSHLESS motors with BRAKE (1000W)

Axial load [N]

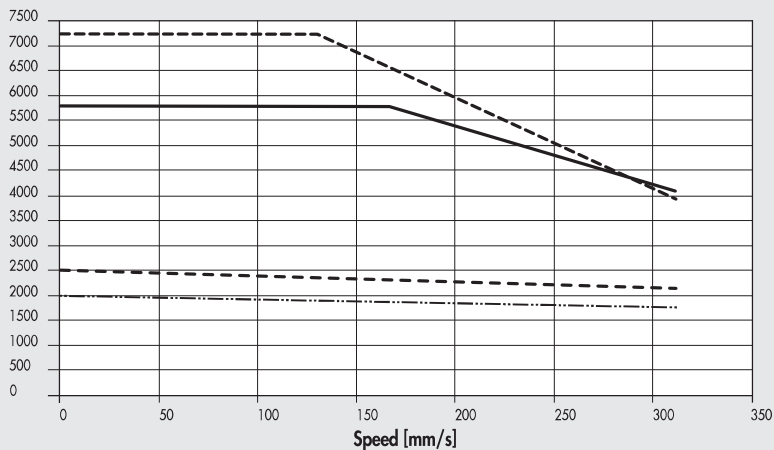

———— Maximum 37M2540000
or 37M4540000 (with brake)
+ 37D2400008 (1000W) in-line version (1:1)

..... Nominal 37M2540000
or 37M4540000 (with brake)
+ 37D2400008 (1000W) in-line version (1:1)

----- Maximum 37M2540000
or 37M4540000 (with brake)
+ 37D2400008 (1000W) geared version (1:1.25)

----- Nominal 37M2540000
or 37M4540000 (with brake)
+ 37D2400008 (1000W) geared version (1:1.25)

Ø 80 with pitch 10 screw, BRUSHLESS motors and BRUSHLESS motors with BRAKE (3000W)

Axial load [N]

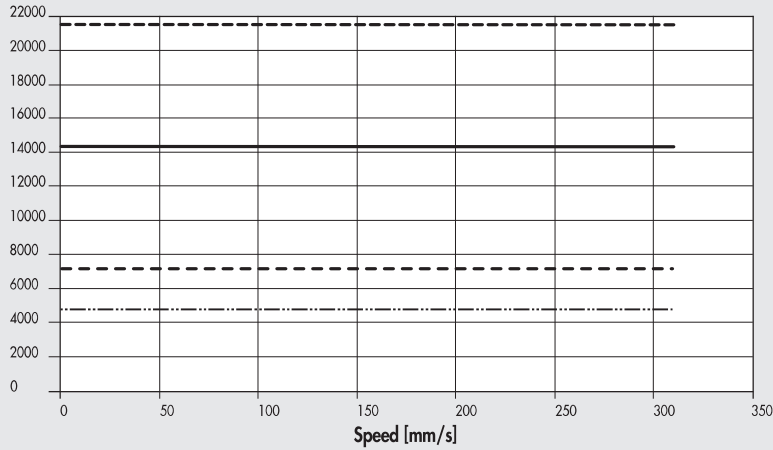

- Maximum 37M2770000 or 37M4770000 (with brake) + 37D2600001 (3000W) in-line version (1:1)
- · - · - Nominal 37M2770000 or 37M4770000 (with brake) + 37D2600001 (3000W) in-line version (1:1)
- - - Maximum 37M2770000 or 37M4770000 (with brake) + 37D2600001 (3000W) geared version (1:1.5)
- · · · · Nominal 37M2770000 or 37M4770000 (with brake) + 37D2600001 (3000W) geared version (1:1.5)

Ø 80 with pitch 32 screw, BRUSHLESS motors and BRUSHLESS motors with BRAKE (3000W)

Axial load [N]

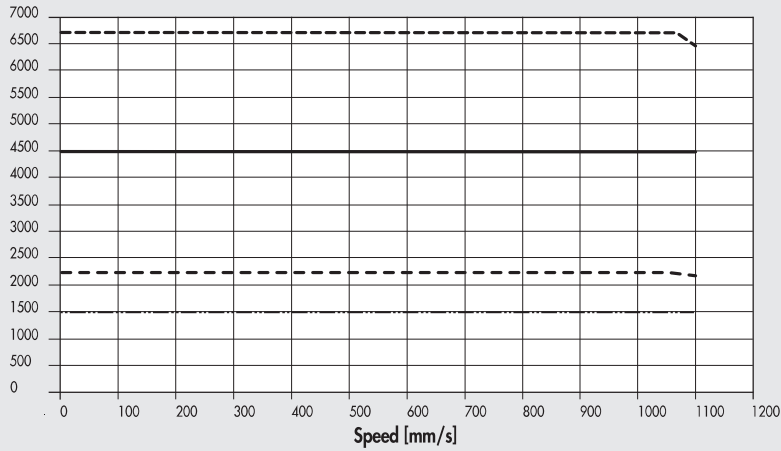

- Maximum 37M2770000 or 37M4770000 (with brake) + 37D2600001 (3000W) in-line version (1:1)
- · - · - Nominal 37M2770000 or 37M4770000 (with brake) + 37D2600001 (3000W) in-line version (1:1)
- - - Maximum 37M2770000 or 37M4770000 (with brake) + 37D2600001 (3000W) geared version (1:1.5)
- · · · · Nominal 37M2770000 or 37M4770000 (with brake) + 37D2600001 (3000W) geared version (1:1.5)

Ø 100 with pitch 10 screw, BRUSHLESS motors and BRUSHLESS motors with BRAKE (3000W)

Axial load [N]

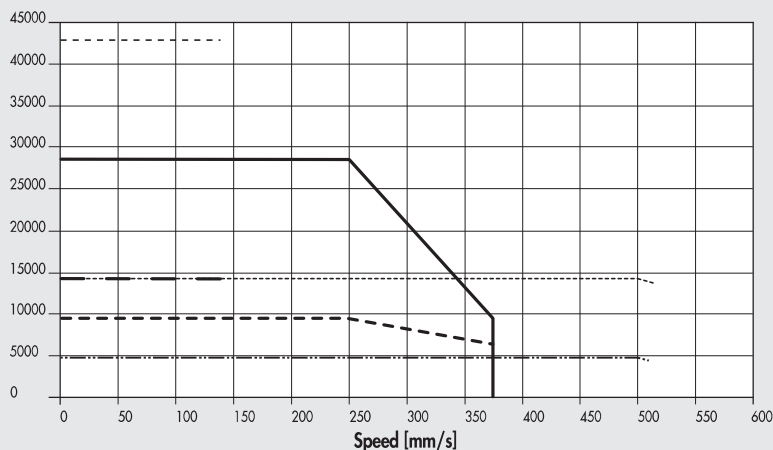

- - - - - Maximum 37M2770000 or 37M4770000 (with brake) + 37D2600001 (3000W) in-line version with gearbox (1:3)
- · - · - Nominal 37M2770000 or 37M4770000 (with brake) + 37D2600001 (3000W) in-line version with gearbox (1:3)
- Maximum 37M2770000 or 37M4770000 (with brake) + 37D2600001 (3000W) geared version (1:2)
- · · · · Nominal 37M2770000 or 37M4770000 (with brake) + 37D2600001 (3000W) geared version (1:2)
- · - · - Maximum 37M2770000 or 37M4770000 (with brake) + 37D2600001 (3000W) in-line version (1:1)
- · - · - Nominal 37M2770000 or 37M4770000 (with brake) + 37D2600001 (3000W) in-line version (1:1)

Ø 100 with pitch 40 screw, BRUSHLESS motors and BRUSHLESS motors with BRAKE (3000W)

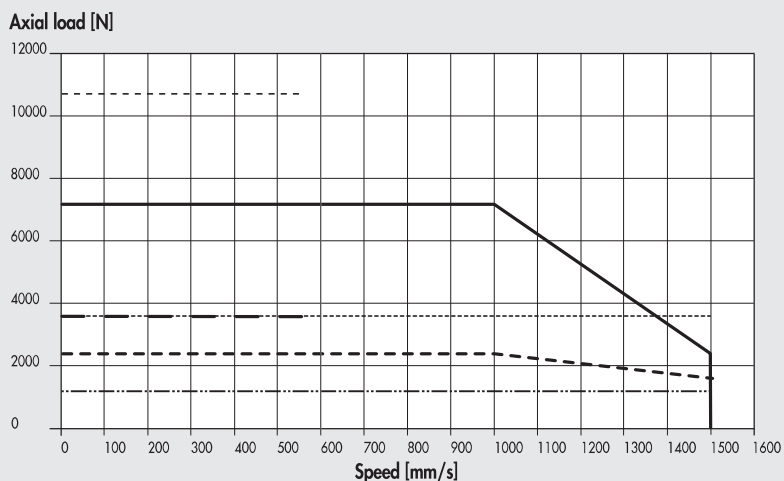

- Maximum 37M2770000 or 37M4770000 (with brake) + 37D2600001 (3000W) in-line version with gearbox (1:3)
- - - - - Nominal 37M2770000 or 37M4770000 (with brake) + 37D2600001 (3000W) in-line version with gearbox (1:3)
- Maximum 37M2770000 or 37M4770000 (with brake) + 37D2600001 (3000W) geared version (1:2)
- - - - - Nominal 37M2770000 or 37M4770000 (with brake) + 37D2600001 (3000W) geared version (1:2)
- Maximum 37M2770000 or 37M4770000 (with brake) + 37D2600001 (3000W) in-line version (1:1)
- Nominal 37M2770000 or 37M4770000 (with brake) + 37D2600001 (3000W) in-line version (1:1)

LUBRICATION DIAGRAMS

LUBRICATION OF VERSION WITH NON-ROTATING PISTON ROD

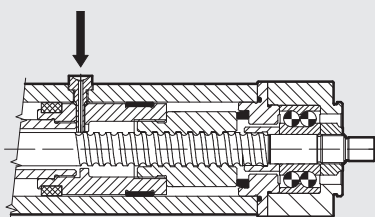

- Retract the piston rod towards the rear head. The piston rod/piston/ball screw system must rest against the buffer of the rear head.
- Unscrew the cap on the lubricator port (see note 1 in the drawing on next page).
- Screw the lubricating pin (see accessory on page A5.37) into the thread. Make sure you enter the corresponding hole in the piston below.
- Pump grease (code 9910506) using the suitable lubricator according to the quantity in table.
- Unscrew the lubricating pin and make the piston rod perform four complete strokes. The piston rod should end up in the initial (retracted) position.
- Repeat the last two operations.
- The operation of re-greasing will have to be repeated at least once a year.

LUBRICATION OF VERSION WITHOUT NON-ROTATING PISTON ROD

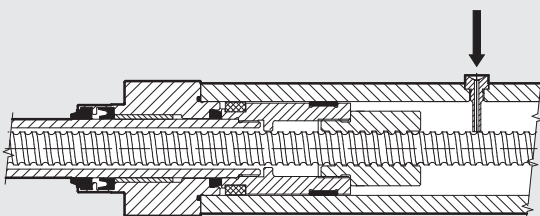

- Extend the piston rod completely. The piston rod/piston/ball screw system must rest against the buffer of the front head.
- Unscrew the cap on the lubricator port (see note 1 in the drawing on next page).
- Screw the lubricating pin (see accessory on page A5.37) into the thread. Make sure you enter the corresponding hole in the piston below.
- Pump grease (code 9910506) using the suitable lubricator according to the quantity in table.
- Unscrew the lubricating pin and make the piston rod perform four complete strokes. The piston rod should end up in the initial (extended) position.
- Repeat the last two operations.
- The operation of re-greasing will have to be repeated at least once a year.

		Ø 32		Ø 50			Ø 63			Ø 63 HD		Ø 80		Ø 100		
Screw pitch (p)	mm	4	12	5	10	16	5	10	20	5	10	5	10	32	10	40
Relube grease quantity	g	0.3	0.6	0.9	1.5	2.1	1.5	1.8	3	1.5	1.8	2.1	3.3	4.8	7.2	12.9
	cc	0.26	0.52	0.77	1.30	1.81	1.30	1.55	2.60	1.30	1.55	1.81	2.84	4.13	6.20	11.10

N.B.: These are indicative values that can change as a function of the stroke

DIMENSIONS

CYLINDER DIMENSIONS (WITHOUT MOTOR)

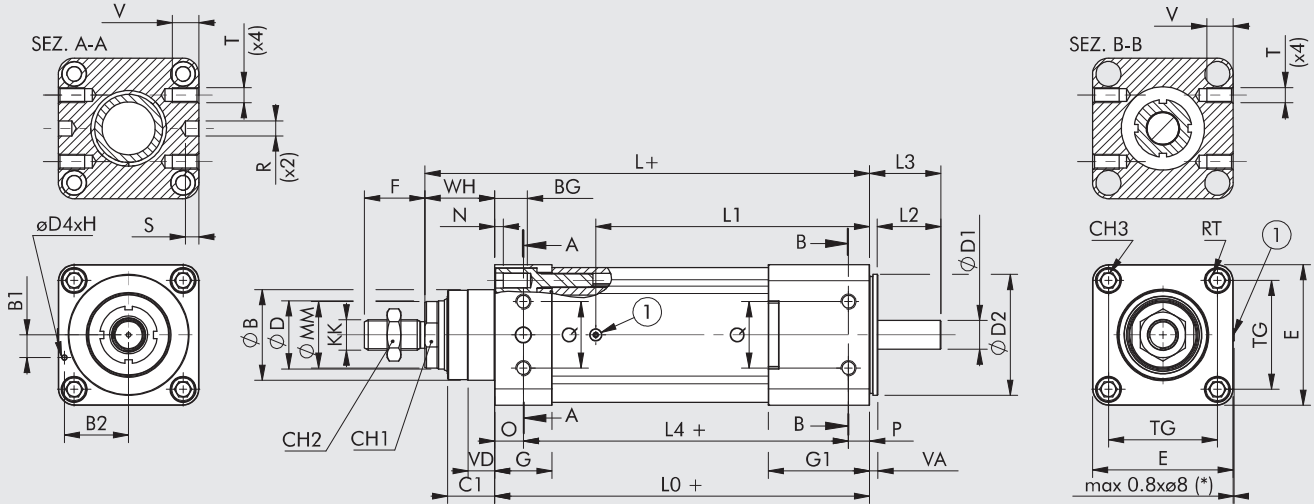

① = lubricator port
 (*) = only for $\varnothing 63 - \varnothing 80 - \varnothing 100$
 + = add the stroke

Ø	ØB (d11)	B1	B2	BG	C1	CH1	CH2	CH3	ØD (f7)	ØD1 (h7)	ØD2	ØD4 (h7)	E	F	G	G1	H	KK	L	L0
32	30	7	19.5	14.5	16	17	17	6	20	6.35	32	3	46	22	26	26	9	M10x1.25	160	134
50	40	7	28	17.5	25	21	24	8	25	10	50	3	64.5	32	30	30	9	M16x1.5	194	157
63	45	9	34.5	17.5	25	26	24	8	30	12	63	3	75.5	32	32	32	9	M16x1.5	210	173
63 HD	45	9	34.5	17.5	25	26	24	8	30	12	63	3	75.5	32	32	46	9	M16x1.5	230	193
80	60	15	42.5	21	31	41	30	10	45	19	80	3	93	40	38	67	9	M20x1.5	294	248
100	90	25	21	21	34	65	30	10	70	24	100	5	110	40	38	77	9	M20x1.5	321.5	270.5

Ø	L1	L2	L3	L4	ØMM	N	O	P	Q	R (h7)	S	T	V	RT	TG	VA	VD	WH
32	86.3	23	27	-	19	4.5	-	-	-	-	-	-	-	M6	32.5	3	4.5	26
50	100.8	24	28.4	-	24	5.5	-	-	-	-	-	-	-	M8	46.5	5.5	5.5	37
63	112.3	34	39.5	-	29	5.5	-	-	-	-	-	-	-	M8	56.5	5.5	6.5	37
63 HD	132.3	34	39.5	-	29.5	5.5	-	-	-	-	-	-	-	M8	56.5	5.5	6.5	37
80	181.1	41.7	47.2	215	42	5	19	14	44	10	9	M10	17.5	M10	72	5.5	17.5	46
100	200.6	46.9	54.9	232.5	69	5	19	19	58	12	9	M12	20	M10	89	8	20	51

NOTES

DIMENSIONS OF CYLINDERS WITH IN-LINE MOTOR

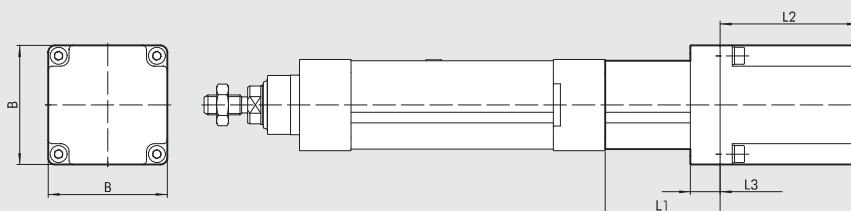

For any missing dimensions, please refer to page A5.25

VERSION WITH MOTOR

Size	Motor type	Code for cylinder complete with motor	Code for motor mounted on the cylinder	Motor torque [Nm]	Coupling flange	B	L1	L2	L3
32	BRUSHLESS	371032 _____ 2200	37M2200000	0.64	60	60	62	69.5	15
		371032 _____ 2220	37M2220000	1.27	60	60	62	95.5	15
	STEPPING	371032 _____ 1110	37M1110000	0.8	NEMA 23	56	45	53.8	12
		371032 _____ 1120	37M1120000	1.2	NEMA 23	56	45	75.8	12
		371032 _____ 1121	37M1120001	1.2	NEMA 23	56	45	75.8	12
50	BRUSHLESS	371050 _____ 2330	37M2330000	2.39	80	80	77.4	107.3	35
63	STEPPING	371063 _____ 1450	37M1450000	6.7	NEMA 34	85.5	63.5	127	16
63 HD	STEPPING	371H63 _____ 1450	37M1450000	6.7	NEMA 34	85.5	63.5	127	16
		371H63 _____ 1470	37M1470000	9.3	NEMA 34	86.6	63.5	130	16
80	BRUSHLESS	371080 _____ 2770	37M2770000	9.5	130	130	120	187.5	26
100	BRUSHLESS	371100 _____ 2770	37M2770000	9.5	130	130	126	187.5	40

VERSION WITH MOTOR AND BRAKE

Size	Motor type	Code for cylinder complete with motor	Code for motor mounted on the cylinder	Motor torque [Nm]	Coupling flange	B	L1	L2	L3
32	BRUSHLESS	371032 _____ 4200	37M4200000	0.64	60	60	62	97.5	15
		371032 _____ 4220	37M4220000	1.27	60	60	62	123.5	15
	STEPPING	371032 _____ 3220	37M3220000	1.2	60	60	45	151.8	7
		371032 _____ 3230	37M3230000	2.5	60	60	45	184.5	7
		371032 _____ 5120	37M5120000	1.2	NEMA 23	56	45	112	12
50	BRUSHLESS	371050 _____ 4330	37M4330000	2.39	80	80	77.4	143	35
	STEPPING	371050 _____ 3430	37M3430000	2.9	NEMA 34	86.6	63.4	156.5	9.9
		371050 _____ 3460	37M3460000	5.5	NEMA 34	86.6	63.4	188.5	9.9
63	STEPPING	371063 _____ 3460	37M3460000	5.5	NEMA 34	86.6	63.5	188.5	9.9
		371063 _____ 3450	37M3450000	6.3	NEMA 34	86.6	63.5	188.5	9.9
63 HD	STEPPING	371H63 _____ 3450	37M3450000	6.3	NEMA 34	86.6	63.5	188.5	16
		371H63 _____ 3460	37M3460000	5.5	NEMA 34	86.6	63.5	188.5	16
		371H63 _____ 3470	37M3470000	9.3	NEMA 34	86.6	63.5	220.5	16
80	BRUSHLESS	371080 _____ 4770	37M4770000	9.5	130	130	120	216	26
100	BRUSHLESS	371100 _____ 4770	37M4770000	9.5	130	130	126	216	40

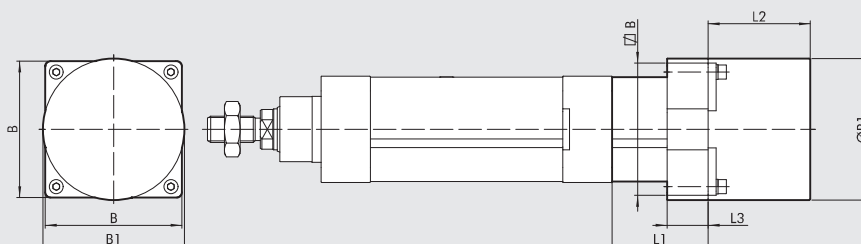

For any missing dimensions, please refer to page A5.25

VERSION WITH MOTOR

Size	Motor type	Code for cylinder complete with motor	Code for motor mounted on the cylinder	Motor torque [Nm]	Coupling flange	B	Ø B1	L1	L2	L3
50	STEPPING	371050 _____ 1430	37M1430000	2.4	NEMA 34	83	86	61.4	62	25
		371050 _____ 1440	37M1440000	4.2	NEMA 34	83	86	61.4	92.2	25
80	STEPPING	371080 _____ 1890	37M1890000	17.5	NEMA 42	106.4	106.4	102	221	35
100	STEPPING	371100 _____ 1890	37M1890000	17.5	NEMA 42	110	106.4	109	221	35

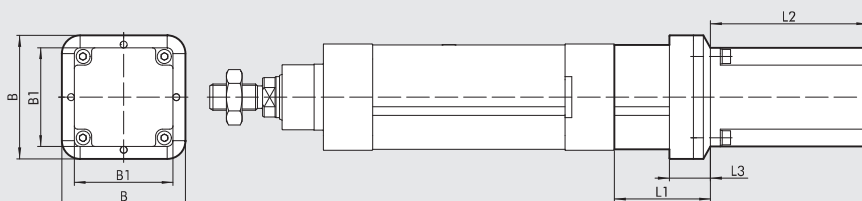
DIMENSIONS OF CYLINDERS WITH IN-LINE MOTOR

For any missing dimensions, please refer to page A5.25

VERSION WITH MOTOR

Size	Motor type	Code for cylinder complete with motor	Code for motor mounted on the cylinder	Motor torque [Nm]	Coupling flange	B	B1	L1	L2	L3
50	BRUSHLESS	371050 _____ 2220	37M2220000	1.27	60	74.5	60	61.4	95.5	25
63	BRUSHLESS	371063 _____ 2330	37M2330000	2.39	80	94	80	78.5	107.3	25
63 HD	BRUSHLESS	371H63 _____ 2330	37M2330000	2.39	80	94	80	78.5	107.3	25
		371H63 _____ 2540	37M2540000	3.18	86	94	84.4	78.5	137.1	25
80	BRUSHLESS	371080 _____ 2540	37M2540000	3.18	86	93	84.4	102	137.1	35

VERSION WITH MOTOR AND BRAKE

Size	Motor type	Code for cylinder complete with motor	Code for motor mounted on the cylinder	Motor torque [Nm]	Coupling flange	B	B1	L1	L2	L3
50	BRUSHLESS	371050 _____ 4220	37M4220000	1.27	60	74.5	60	61.4	123.5	25
63	BRUSHLESS	371063 _____ 4330	37M4330000	2.39	80	94	80	78.5	143	25
63 HD	BRUSHLESS	371H63 _____ 4330	37M4330000	2.39	80	94	80	78.5	143	25
		371H63 _____ 4540	37M4540000	3.18	86	94	84.4	78.5	163	25
80	BRUSHLESS	371080 _____ 4540	37M4540000	3.18	86	93	84.4	102	163	35

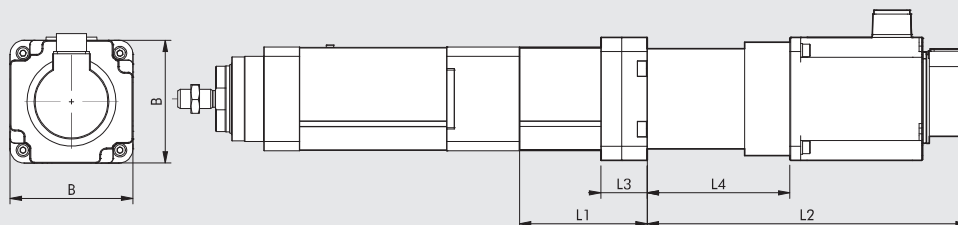
DIMENSIONS OF CYLINDERS WITH IN-LINE MOTOR AND GEARBOX

For any missing dimensions, please refer to page A5.25

VERSION WITH MOTOR

Size	Motor type	Code for cylinder complete with motor	Code for motor mounted on the cylinder	Code for gear mounted on the cylinder	Motor torque [Nm]	Coupling flange	B	L1	L2	L3	L4
100	BRUSHLESS	371100 _____ 6770	37M2770000	37R0364000	9.5	130	130	135	338.5	49	151

VERSION WITH MOTOR AND BRAKE

Size	Motor type	Code for cylinder complete with motor	Code for motor mounted on the cylinder	Code for gear mounted on the cylinder	Motor torque [Nm]	Coupling flange	B	L1	L2	L3	L4
100	BRUSHLESS	371100 _____ 7770	37M4770000	37R0364000	9.5	130	130	135	367	49	151

DIMENSIONS OF CYLINDERS WITH GEARED MOTOR

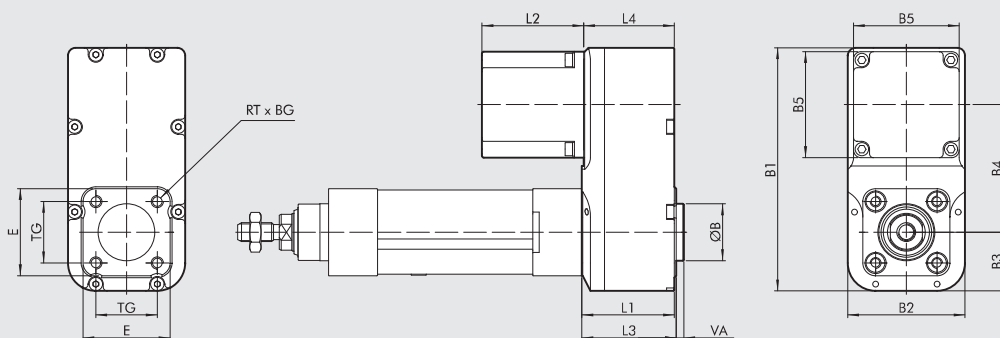

For any missing dimensions, please refer to page A5.25

VERSION WITH MOTOR

Size	Motor type	Code for cylinder complete with motor	Code for motor mounted on the cylinder	Motor torque [Nm]	Coupling flange	ØB (d11)	B1	B2	B3	B4	B5	BG	E	L1	L2	L3	L4	TG	RT	VA
32	STEPPING	371032_1110	37M1110000	0.8	NEMA 23	30	128.5	62	31	67.5	56	15	46	49	53.8	50	48	32.5	M6	4
		371032_1120	37M1120000	1.2	NEMA 23	30	128.5	62	31	67.5	56	15	46	49	75.8	50	48	32.5	M6	4
		371032_1121	37M1120001	1.2	NEMA 23	30	128.5	62	31	67.5	56	15	46	49	75.8	50	48	32.5	M6	4
63	STEPPING	371063_1450	37M1450000	6.7	NEMA 34	45	179.5	92	46	87.5	84.5	17	75.5	70	127	72	68	56.5	M8	4
63 HD	STEPPING	371H63_1450	37M1450000	6.7	NEMA 34	45	179.5	92	46	87.5	85.5	17	75.5	70	127	72	68	56.5	M8	4
80	BRUSHLESS	371080_2540	37M2540000	3.18	86	45	204.5	115	57	97.5	86	21	-	80.5	137.1	-	-	72	M10	4

VERSION WITH MOTOR AND BRAKE

Size	Motor type	Code for cylinder complete with motor	Code for motor mounted on the cylinder	Motor torque [Nm]	Coupling flange	ØB (d11)	B1	B2	B3	B4	B5	BG	E	L1	L2	L3	L4	TG	RT	VA
32	STEPPING	371032_3220	37M3220000	1.2	60	30	128.5	62	31	67.5	60	15	46	49	151.8	50	48	32.5	M6	4
		371032_3230	37M3230000	2.5	60	30	128.5	62	31	67.5	60	15	46	49	184.5	50	48	32.5	M6	4
		371032_5120	37M5120000	1.2	NEMA 23	30	128.5	62	31	67.5	56	15	46	49	112	50	48	32.5	M6	4
80	BRUSHLESS	371080_4540	37M4540000	3.18	86	45	204.5	115	57	97.5	86	21	-	80.5	163	-	-	72	M10	4

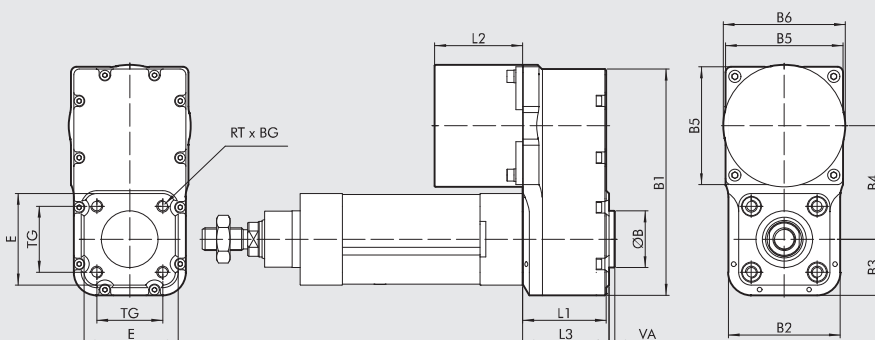

For any missing dimensions, please refer to page A5.25

VERSION WITH MOTOR

Size	Motor type	Code for cylinder complete with motor	Code for motor mounted on the cylinder	Motor torque [Nm]	Coupling flange	ØB (d11)	B1	B2	B3	B4	B5	ØB6	BG	E	L1	L2	L3	TG	RT	VA
50	STEPPING	371050_1430	37M1430000	2.4	NEMA 34	40	159.5	79	39.5	80	80	86	17	64.5	59	62	61	46.5	M8	4
		371050_1440	37M1440000	4.2	NEMA 34	40	159.5	79	39.5	80	83	86	17	64.5	59	92.2	61	46.5	M8	4

DIMENSIONS OF CYLINDERS WITH GEARED MOTOR

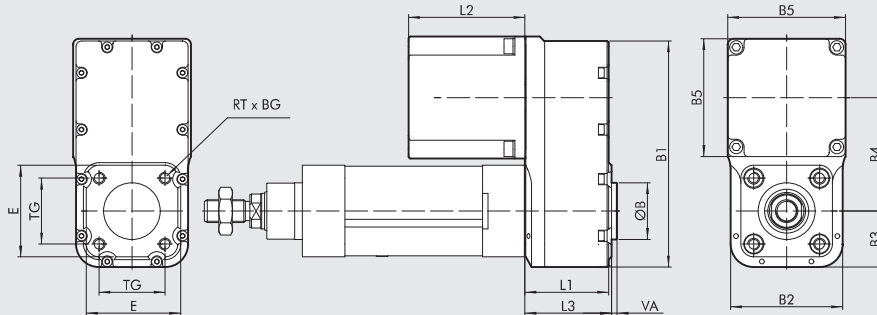

VERSION WITH MOTOR AND BRAKE

For any missing dimensions, please refer to page A5.25

Size	Motor type	Code for cylinder complete with motor	Code for motor mounted on the cylinder	Motor torque [Nm]	Coupling flange	ØB (d11)	B1	B2	B3	B4	B5	BG	E	L1	L2	L3	TG	RT	VA
50	STEPPING	371050 _____ 3430	37M3430000	2.9	NEMA 34	40	159.5	79	39.5	80	86.6	17	64.5	59	156.5	61	46.5	M8	4
		371050 _____ 3460	37M3460000	5.5	NEMA 34	40	159.5	79	39.5	80	86.6	17	64.5	59	188.5	61	46.5	M8	4

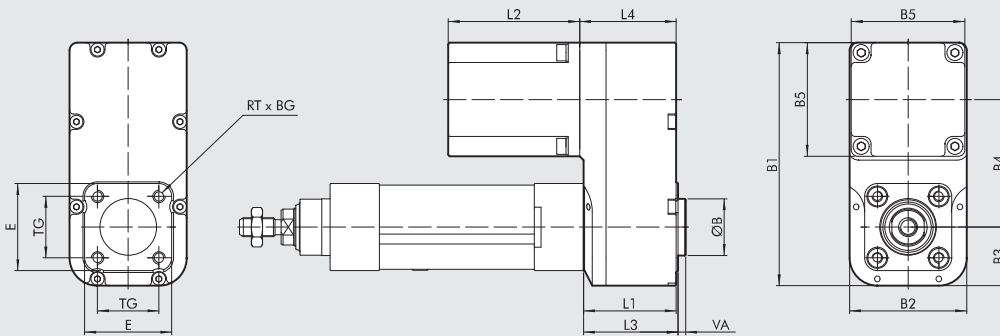

VERSION WITH MOTOR

For any missing dimensions, please refer to page A5.25

Size	Motor type	Code for cylinder complete with motor	Code for motor mounted on the cylinder	Motor torque [Nm]	Coupling flange	ØB (d11)	B1	B2	B3	B4	B5	BG	E	L1	L2	L3	L4	TG	RT	VA
32	BRUSHLESS	371032 _____ 2200	37M2200000	0.64	60	30	128.5	62	31	67.5	60	15	46	49	69.5	50	51	32.5	M6	4
		371032 _____ 2220	37M2220000	1.27	60	30	128.5	62	31	67.5	60	15	46	49	95.5	50	51	32.5	M6	4

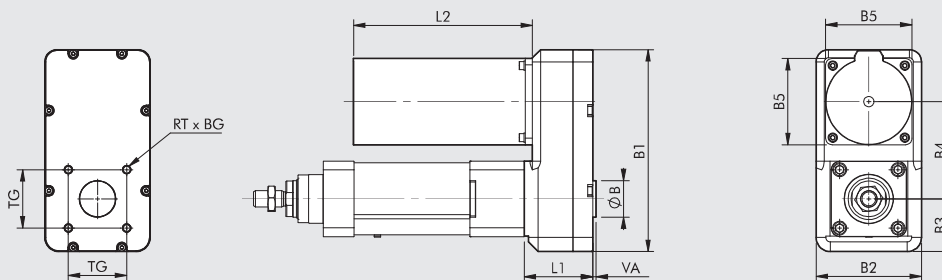

VERSION WITH MOTOR

For any missing dimensions, please refer to page A5.25

Size	Motor type	Code for cylinder complete with motor	Code for motor mounted on the cylinder	Motor torque [Nm]	Coupling flange	ØB (d11)	B1	B2	B3	B4	B5	BG	L1	L2	TG	RT	VA
80	STEPPING	371080 _____ 1890	37M1890000	17.5	NEMA 42	45	249	130	65	120	106.4	21	84.5	221	72	M10	4
100	STEPPING	371100 _____ 1890	37M1890000	17.5	NEMA 42	55	285	150	75	120	106.4	21	91.5	221	89	M10	4

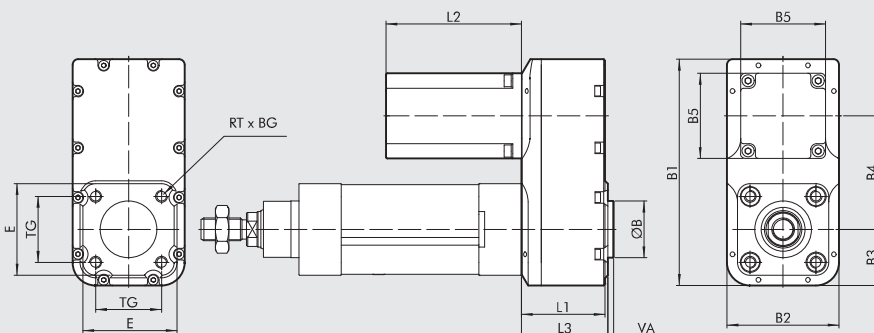

For any missing dimensions, please refer to page A5.25

VERSION WITH MOTOR

Size	Motor type	Code for cylinder complete with motor	Code for motor mounted on the cylinder	Motor torque [Nm]	Coupling flange	ØB (d11)	B1	B2	B3	B4	B5	BG	E	L1	L2	L3	TG	RT	VA
50	BRUSHLESS	371050_2220	37M2220000	1.27	60	40	159.5	79	39.5	80	60	17	64.5	59	95.5	61	46.5	M8	4
63	BRUSHLESS	371063_2330	37M2330000	2.39	80	45	179.5	92	46	87.5	80	17	75.5	70	107.3	72	56.5	M8	4
63 HD	BRUSHLESS	371H63_2330	37M2330000	2.39	80	45	179.5	92	46	87.5	80	17	75.5	70	107.3	72	56.5	M8	4
		371H63_2540	37M2540000	3.18	86	45	179.5	92	46	87.5	86	17	75.5	70	137.1	72	56.5	M8	4
	STEPPING	371H63_1470	37M1470000	9.3	NEMA 34	45	179.5	92	46	87.5	86.6	17	75.5	70	130	72	56.5	M8	4

VERSION WITH MOTOR AND BRAKE

Size	Motor type	Code for cylinder complete with motor	Code for motor mounted on the cylinder	Motor torque [Nm]	Coupling flange	ØB (d11)	B1	B2	B3	B4	B5	BG	E	L1	L2	L3	TG	RT	VA
50	BRUSHLESS	371050_4220	37M4220000	1.27	60	40	159.5	79	39.5	80	60	17	64.5	59	123.5	61	46.5	M8	4
63	BRUSHLESS	371063_4330	37M4330000	2.39	80	45	179.5	92	46	87.5	80	17	75.5	70	143	72	56.5	M8	4
	STEPPING	371063_3460	37M3460000	5.5	NEMA 34	45	179.5	92	46	87.5	86.6	17	75.5	70	188.5	72	56.5	M8	4
		371063_3450	37M3450000	6.3	NEMA 34	45	179.5	92	46	87.5	86.6	17	75.5	70	188.5	72	56.5	M8	4
63 HD	BRUSHLESS	371H63_4330	37M4330000	2.39	80	45	179.5	92	46	87.5	80	17	75.5	70	143	72	56.5	M8	4
		371H63_4540	37M4540000	3.18	86	45	179.5	92	46	87.5	86	17	75.5	70	163	72	56.5	M8	4
	STEPPING	371H63_3470	37M3470000	9.3	NEMA 34	45	179.5	92	46	87.5	86.6	17	75.5	70	220.5	72	56.5	M8	4
		371H63_3450	37M3450000	6.3	NEMA 34	45	179.5	92	46	87.5	86.6	17	75.5	70	188.5	72	56.5	M8	4
		371H63_3460	37M3460000	5.5	NEMA 34	45	179.5	92	46	87.5	86.6	17	75.5	70	188.5	72	56.5	M8	4

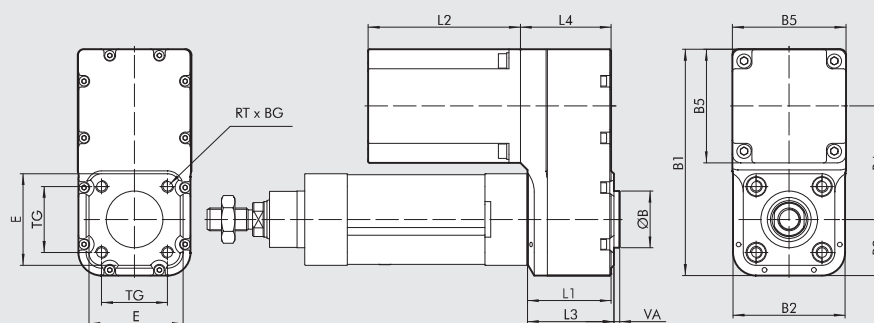

For any missing dimensions, please refer to page A5.25

VERSION WITH MOTOR

Size	Motor type	Code for cylinder complete with motor	Code for motor mounted on the cylinder	Motor torque [Nm]	Coupling flange	ØB (d11)	B1	B2	B3	B4	B5	BG	E	L1	L2	L3	L4	TG	RT	VA
50	BRUSHLESS	371050_2330	37M2330000	2.39	80	40	159.5	79	39.5	80	80	17	64.5	59	107.3	61	64	46.5	M8	4
80	BRUSHLESS	371080_2770	37M2770000	9.5	130	45	249	130	65	119	130	21	-	84.5	187.5	-	-	72	M10	4
100	BRUSHLESS	371100_2770	37M2770000	9.5	130	55	285	150	75	145	130	21	-	91.5	187.5	-	-	89	M10	4

VERSION WITH MOTOR AND BRAKE

Size	Motor type	Code for cylinder complete with motor	Code for motor mounted on the cylinder	Motor torque [Nm]	Coupling flange	ØB (d11)	B1	B2	B3	B4	B5	BG	E	L1	L2	L3	L4	TG	RT	VA
32	BRUSHLESS	371032_4200	37M4200000	0.64	60	30	128.5	62	31	67.5	60	15	46	49	67.5	50	51	32.5	M6	4
		371032_4220	37M4220000	1.27	60	30	128.5	62	31	67.5	60	15	46	49	123.5	50	51	32.5	M6	4
50	BRUSHLESS	371050_4330	37M4330000	2.39	80	40	159.5	79	39.5	80	80	17	64.5	59	143	61	64	46.5	M8	4
80	BRUSHLESS	371080_4770	37M4770000	9.5	130	45	249	130	65	119	130	21	-	84.5	216	-	-	72	M10	4
100	BRUSHLESS	371100_4770	37M4770000	9.5	130	55	285	150	75	145	130	21	-	91.5	216	-	-	89	M10	4

MOTOR-DRIVE COUPLINGS



MOTOR CODES		DRIVES CODES				
		Metal Work Manufacturer	37D1222000 * RTA CSD 94 (4.4A 24-48VDC)	37D1332000 * RTA NDC 96 (6A 2-75VDC)	37D1442000 RTA PLUS A4 (6A 77-140VDC)	37D1552000 RTA PLUS B7 (10A 28-62VAC) ●
Metal Work	Manufacturer					
STEPPING MOTORS						
37M1110000	SANYO DENKI 103-H7123-1749 (4A 75V max)	Ø32	Ø32 ◆	-	Ø32 ■	-
37M1120000	SANYO DENKI 103-H7126-1740 (4A 75V max)	Ø32	Ø32 ◆	-	Ø32 ■	-
37M1120001	SANYO DENKI 103-H7126-6640 (5.6A 75V max)	-	Ø32	-	Ø32 ■	-
37M1430000	SANYO DENKI 103-H8221-6241 (6A 140V max)	-	Ø50	Ø 50	Ø50 ◆	Ø50 ▲
37M1440000	SANYO DENKI 103-H8222-6340 (6A 140V max)	-	Ø50	Ø 50	Ø50 ◆	Ø50 ▲
37M1450000	SANYO DENKI SM-2863-5255 (6A 140V max)	-	Ø63 - Ø63 HD	Ø63 - Ø63 HD	Ø63 - Ø63 HD ◆	Ø63 - Ø63 HD ▲
37M1470000	B&R 80MPH6.101S000-01 (10A 80V max)	-	-	-	Ø63 HD	-
37M1890000	SANYO DENKI 103-H89223-6341 (6A 230V max)	-	-	-	-	Ø80 - Ø100
STEPPING MOTORS WITH BRAKE						
37M5120000	SANYO DENKI 103-H7126-1710B (4A 75V max)	Ø32	Ø32 ◆	-	Ø32 ■	-
STEPPING MOTORS WITH BRAKE + ENCODER						
37M3220000	B&R 80MPF3.500D114-01 (5A 80V max)	-	Ø32 ◆	Ø32 ■	Ø32 ■	-
37M3230000	B&R 80MPF5.500D114-01 (5A 80V max)	-	Ø32 ◆	Ø32 ■	Ø32 ■	-
37M3430000	B&R 80MPH1.600D114-01 (6A 80V max)	-	Ø50	Ø50 ▲	Ø50 ◆	-
37M3460000	B&R 80MPH3.600D114-01 (6A 80V max)	-	Ø50 - Ø63 - Ø63 HD	Ø50 - Ø63 - Ø63 HD ▲	Ø50 - Ø63 - Ø63 HD ◆	-
37M3450000	B&R 80MPH4.101D114-01 (10A 80V max)	-	-	-	Ø63 - Ø63 HD	-
37M3470000	B&R 80MPH6.101D114-01 (10A 80V max)	-	-	-	Ø63 HD	-

* In all applications requiring motor powered up to 6A / 55VDC, the programmable drive e.drive, code 37D1332002, can be used.

◆ Important! Limit current

■ Important! Limit current and voltage

▲ Important! Limit voltage

● Important! AC drive to continuous voltage $VDC = VAC \cdot \sqrt{2}$

MOTOR CODES		DRIVES CODES	
		Metal Work Manufacturer	37D2400008 SANYO DENKI RS3A03 (30A 200-1000 W)
Metal Work	Manufacturer		
BRUSHLESS MOTORS			
37M2200000	SANYO DENKI R2AA06020FXH11M (200W)	Ø32	-
37M2220000	SANYO DENKI R2AA06040FXH11M (400W)	Ø32 - Ø50	-
37M2330000	SANYO DENKI R2AA08075FXH11M (750W)	Ø50 - Ø63 - Ø63 HD	-
37M2540000	SANYO DENKI R2AA8100HXH29M (1000W)	Ø63 HD - Ø80	-
37M2770000	DELTA ECMA-J11330R4 (3000W)	-	Ø80 - Ø100
BRUSHLESS MOTORS WITH BRAKE			
37M4200000	SANYO DENKI R2AA06020FCH11M (200W)	Ø32	-
37M4220000	SANYO DENKI R2AA06040FCH11M (400W)	Ø32 - Ø50	-
37M4330000	SANYO DENKI R2AA08075FCH11M (750W)	Ø50 - Ø63 - Ø63 HD	-
37M4540000	SANYO DENKI R2AA8100HCH29M (1000W)	Ø63 HD - Ø80	-
37M4770000	DELTA ECMA-J11330S4 (3000W)	-	Ø80 - Ø100

KEY TO CODES FOR ELECTRIC CYLINDER SERIE ELEKTRO ISO 15552

ACTUATORS

ELECTRIC CYLINDER SERIES ELEKTRO ISO 15552

KEY TO CODES CYLINDER WITHOUT MOTOR

CYL	37 TYPE	1	032 SIZE	0100 STROKE	1 SCREW PITCH	5 VERSION
	37 Electric actuators	1 ISO 15552 electric cylinder	032 32 050 50 063 63 ◆ H63 63 Heavy Duty ◀ 080 80 ◀ 100 100		1 Pitch 4 2 Pitch 5 4 Pitch 10 5 Pitch 12 6 Pitch 16 7 Pitch 20 8 Pitch 32 9 Pitch 40	5 Without non-rotating IP40 6 With non-rotating IP40 7 Without non-rotating IP55/IP65 8 With non-rotating IP55/IP65

N.B.: For the possible ordering codes, please refer to the next page.

- ◆ Only for Ø63 with screw pitch 5 or pitch 10
- ◀ Only for versions 7 and 8

N.B.: An piston rod anti-rotation system must be used. If the piston rod is not fixed firmly to an element, a flange or to any other device preventing it from rotating, a cylinder in the anti-rotation version must be used.

KEY TO CODES CYLINDER WITH MOTOR

CYL	37 TYPE	1	032 SIZE	0100 STROKE	1 SCREW PITCH	1 VERSION	DRIVE			
							1 MOTOR *	2 FLANGE	2 TORQUE	0
	37 Electric actuators	1 ISO 15552 electric cylinder	032 32 050 50 063 63 ◆ H63 63 Heavy Duty ◀ 080 80 ◀ 100 100		1 Pitch 4 2 Pitch 5 4 Pitch 10 5 Pitch 12 6 Pitch 16 7 Pitch 20 8 Pitch 32 9 Pitch 40	IN-LINE ● 1 Without non-rotating IP40/IP20 ● 2 With non-rotating IP40/IP20 ■ 3 Without non-rotating IP55/IP65 ■ 4 With non-rotating IP55/IP65 GEARED ● 5 Without non-rotating IP40/IP20 ● 6 With non-rotating IP40/IP20 ■ 7 Without non-rotating IP55/IP65 ■ 8 With non-rotating IP55/IP65	1 STEPPING 2 BRUSHLESS 3 STEPPING with BRAKE + Encoder 4 BRUSHLESS with BRAKE 5 STEPPING with BRAKE without Encoder 6 BRUSHLESS with gearbox 7 BRUSHLESS with BRAKE + gearbox	1 NEMA 23 2 60 3 80 4 NEMA 34 5 86 7 130 8 NEMA 42	0 0 - 0.79 Nm 1 0.8 - 1.19 Nm 2 1.2 - 2.19 Nm 3 2.2 - 3 Nm 4 3.01 - 5 Nm 5 6.21 - 7 Nm 6 5.01 - 6.2 Nm 7 7.01 - 10 Nm 9 15.01 - 25 Nm	0 Base 1 Greater rpm

N.B.: The Orderable configurations are shown on the next page.

- ◆ Only for Ø63 with screw pitch 5 or pitch 10
- ◀ Only for versions 3, 4, 7 and 8
- Version IP40 available for all STEPPING and BRUSHLESS motors, for only the sizes 32, 50 and 63, with the exception of motor code 37M5120000 which it is IP20;
- Version IP55 available for STEPPING motors, for only the sizes 50, 63, 80 and 100 all the motors, with the exception of motor code 37M1470000; for Ø 32 only for motor code 37M1120001; version IP65 available for BRUSHLESS motors, BRUSHLESS with BRAKE and STEPPING with BRAKE + ENCODER motors (all sizes).
- * On request available versions with gearbox with reduction ratios other than those eventually foreseen as standard.

N.B.: An piston rod anti-rotation system must be used. If the piston rod is not fixed firmly to an element, a flange or to any other device preventing it from rotating, a cylinder in the anti-rotation version must be used.

POSSIBLE ORDERING CODES

Ø 32

Drive	Version	Screw pitch				
371032_	_	_	_	1	1	1110
				5	2	1120
					5	1121
					6	5120
						2200
						2220
						3220
						3230
						4200
						4220
					3	1121
					4	2200
					7	2220
					8	3220
		3230				
		4200				
		4220				

_____ = Enter the stroke in mm

Ø 50

Drive	Version	Screw pitch				
371050_	_	_	_	2	1	1430
				4	2	1440
				6	3	2220
					4	2330
					5	3430
					6	3460
					7	4220
					8	4330

_____ = Enter the stroke in mm

Ø 63

Drive	Version	Screw pitch				
371063_	_	_	_	2	1	1450
				4	2	2330
				7	3	3450
					4	3460
					5	4330
					6	
					7	
					8	

_____ = Enter the stroke in mm

Ø 63 HD

Drive	Version	Screw pitch				
371H63_	_	_	_	2	1	1450
				4	2	1470
					5	2330
					6	2540
						3450
						3460
						3470
						4330
						4540
					3	1450
					4	2330
					7	2540
					8	3450
						3460
		3470				
		4330				
		4540				

_____ = Enter the stroke in mm

Ø 80

Drive	Version	Screw pitch			Transmission ratio *			
371080_	_	_	_	2	3	1890	1	
					4	2540	1	
						4540	1	
					7	1890	1	
					8	2540	4/5	
						4540	4/5	
					4	3	1890	1
					8	4	2540	1
							2770	1
							4540	1
							4770	1
					7	1890	1	
					8	2540	4/5	
							2770	2/3
			4540	4/5				
			4770	2/3				

_____ = Enter the stroke in mm

Ø 100

Drive	Version	Screw pitch			Transmission ratio *			
371100_	_	_	_	4	3	1890	1	
					4	2770	1	
					9	4	4770	1
							6770	1/3
							7770	1/3
					7	1890	1	
					8	2770	1/2	
							4770	1/2

_____ = Enter the stroke in mm

* For sizes Ø80 and Ø100 the standard transmission ratio depends on screw pitch, version and motorization. For the other sizes the standard transmission ratio is 1.

ACCESSORIES FOR ELECTRIC CYLINDER SERIES ELEKTRO ISO 15552

N.B.: Where specified, limit the maximum axial loads (Fmax) according to the electric cylinders

ACTUATORS

ELECTRIC CYLINDER SERIES ELEKTRO ISO 15552

FOOT - MODEL A

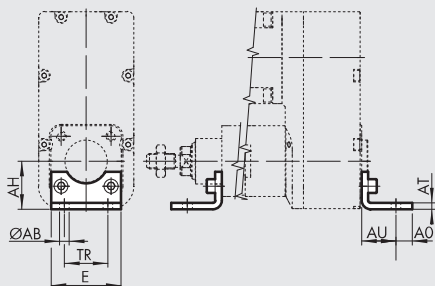

STEEL

Code	Ø	Ø AB	AH	AO	AT	AU	TR	E	Weight [g]	Fmax [N]
W0950322001	32	7	32	11	4	24	32	45	76	1600
W0950502001	50	9	45	15	5	32	45	65	162	4000
W0950632001	63	9	50	15	5	32	50	75	266	6000
W0950632001	63 HD	9	50	15	5	32	50	75	266	6000
W095E802001	80	12	68.5*	20	6	41	63	95	414	10000
W095EA12001	100	14	79*	25	6	41	75	115	518	16000

* Dimensions not to ISO 15552

Note: Individually packed with 2 screws

FOOT ON CYLINDER HEADS

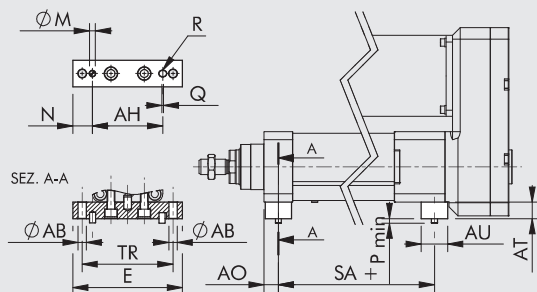

STEEL

Code	Ø	Ø AB	AH	AO	AT	AU	TR	E	ØM ^{H7}	N	P	Q	R ^{H7}	SA	Weight [g]	Fmax [N]
0950807042	80	11	93	19	22	35	120	145	8	26	6	2	8	215	770	10000
0951007042	100	13	111	19	24	35	140	165	8	27	6	2	8	232.5	945	16000

Note: Individually packed with 2 screws, 3 pins

FEMALE HINGE - MODEL B

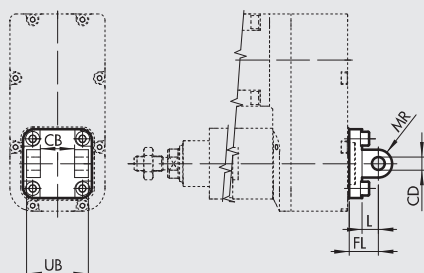

ALUMINIUM

Code	Ø	UB	CB ^{H14}	FL	CD ^{H9}	MR	L	Weight [g]	Fmax [N]
W0950322003	32	45	26	22	10	10	12	116	800
W0950502003	50	60	32	27	12	12	15	252	2000
W0950632003	63	70	40	32	16	16	20	394	3000
W0950632003	63 HD	70	40	32	16	16	20	394	3000

STEEL

Code	Ø	UB	CB ^{H14}	FL	CD ^{H9}	MR	L	Weight [g]	Fmax [N]
W095E322003	32	45	26	22	10	10	13	348	1600
W095E502003	50	60	32	27	12	12	16	756	4000
W095E632003	63	70	40	32	16	15	22	1182	6000
W095E632003	63 HD	70	40	32	16	15	22	1182	6000
W095E802003	80	90	50	36	16	16	22	2010	10000
W095EA12003	100	110	60	41	20	20	27	3255	16000

Note: Supplied with 4 screws, 4 washers, 2 snap-rings, 1 pin

MALE HINGE - MODEL BA

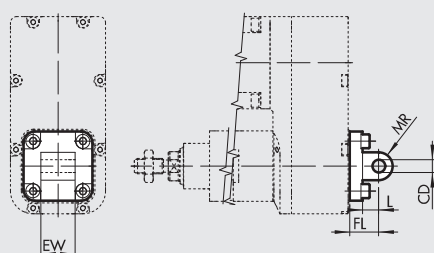

ALUMINIUM

Code	Ø	EW	FL	MR	CD ^{H9}	L	Weight [g]	Fmax [N]
W0950322004	32	26	22	10	10	13	94	800
W0950502004	50	32	27	12	12	16	220	2000
W0950632004	63	40	32	16	16	22	316	3000
W0950632004	63 HD	40	32	16	16	22	316	3000

STEEL

Code	Ø	EW	FL	MR	CD ^{H9}	L	Weight [g]	Fmax [N]
W095E322004	32	26	22	10	10	13	282	1600
W095E502004	50	32	27	12	12	16	660	4000
W095E632004	63	40	32	16	15	22	948	6000
W095E632004	63 HD	40	32	16	15	22	948	6000
W095E802004	80	50	36	16	16	22	1734	10000
W095EA12004	100	60	41	20	20	27	2550	16000

Note: Supplied with 4 screws.

ARTICULATED MALE HINGE - MODEL BAS

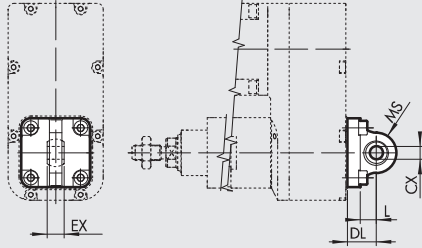

ALUMINIUM

Code	Ø	DL	MS	L	CX ^{H9}	EX	Weight [g]	Fmax [N]
W0950322006	32	22	16	12	10	14	106	800
W0950502006	50	27	21	15	12	16	236	2000
W0950632006	63	32	23	20	16	21	336	3000
W0950632006	63 HD	32	23	20	16	21	336	3000

STEEL

Code	Ø	DL	MS	L	CX ^{H9}	EX	Weight [g]	Fmax [N]
W095E322006	32	22	15	14	10	14	318	1600
W095E502006	50	27	20	17	16	21	708	4000
W095E632006	63	32	23	22	16	21	1008	6000
W095E632006	63 HD	32	23	22	16	21	1008	6000
W095E802006	80	36	27	23	20	25	1716	10000
W095EA12006	100	41	30	28	20	25	2520	16000

Note: Supplied with 4 screws, 4 washers

CETOP HINGE FOR MODEL B - MODEL GL

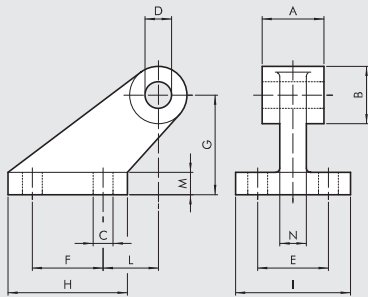

ALUMINIUM

Code	Ø	A	B	C	D	E	F	G	H	I	L	M	N	Weight [g]	Fmax [N]
W0950322008	32	26	19	7	10	25	20	32	37	41	18	8	10	96	800
W0950502008	50	32	26	9	12	32	32	45	54	52	25	10	12	212	2000
W0950632008	63	40	33	11	16	40	50	63	75	63	32	12	15	440	3000
W0950632008	63 HD	40	33	11	16	40	50	63	75	63	32	12	15	440	3000

Note: Supplied with 4 screws, 4 washers

COUNTER-HINGE FOR MODEL B - MODEL GS

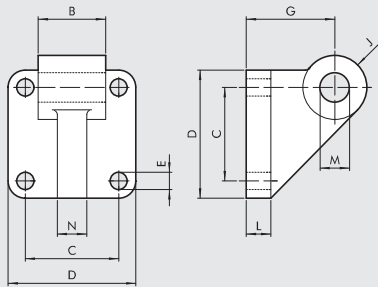

ALUMINIUM

Code	Ø	B	C	D	E	G	J	L	M	N	Weight [g]	Fmax [N]
W0950322108	32	26	32.5	45	7	32	11	10	10	10	106	800
W0950502108	50	32	46.5	65	9	45	13	12	12	12	252	2000
W0950632108	63	40	56.5	75	9	50	17	12	16	15	350	3000
W0950632108	63 HD	40	56.5	75	9	50	17	12	16	15	350	3000

Note: Supplied with 4 screws, 4 washers

ISO 15552 COUNTER-HINGE FOR MODEL B - MODEL AB7

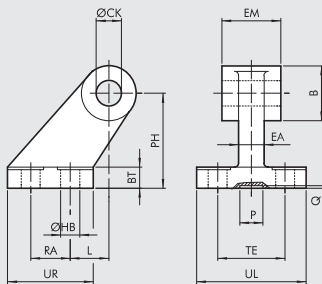

ALUMINIUM

Code	Ø	EM	B	ØHB	ØCK	TE	RA	PH	UR	UL	L	BT	EA	P	Q	Weight [g]	Fmax [N]
W0950322017	32	26	20	6.6	10	38	18	32	31	51	3	8	10	21	3	60	800
W0950502017	50	32	26	9	12	50	30	45	45	65	3	12	16	21	3	162	2000
W0950632017	63	40	30	9	16	52	35	50	50	67	2	14*16	21	3	191	3000	
W0950632017	63 HD	40	30	9	16	52	35	50	50	67	2	14*16	21	3	191	3000	

STEEL

Code	Ø	EM	B	ØHB	ØCK	TE	RA	PH	UR	UL	L	BT	EA	P	Q	Weight [g]	Fmax [N]
W095E322017	32	26	20	6.6	10	38	18	32	31	51	3	8	10	20	5	180	1600
W095E502017	50	32	26	9	12	50	30	45	45	65	3	12	16	30	5	486	4000
W095E632017	63	40	30	9	16	52	35	50	50	67	2	12	16	35	5	573	6000
W095E632017	63 HD	40	30	9	16	52	35	50	50	67	2	12	16	35	5	573	6000
W095E802017	80	50	30	11	16	66	40	63	60	86	7	14	20	45	5	996	10000
W095EA12017	100	60	38	11	20	76	50	71	70	96	5	15	20	55	5	1566	16000

* Dimensions not to ISO 15552

FRONT FLANGE - MODEL C

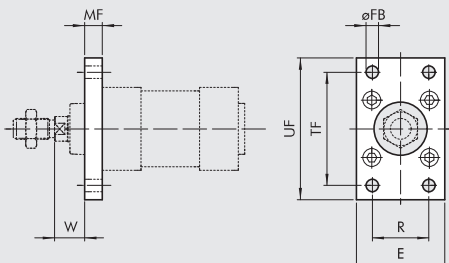

Code	Ø	TF	UF	E	MF	R	øFB	W	Weight [g]	Fmax [N]
W0950322002	32	64	80	50	10	32	7	16	246	1600
W0950502002	50	90	110	65	12	45	9	25	522	5000
W0950632002	63	100	120	75	12	50	9	25	670	7000
W0950632002	63 HD	100	120	75	12	50	9	25	670	7000

Note: Supplied with 4 screws

ROD NUT - MODEL S

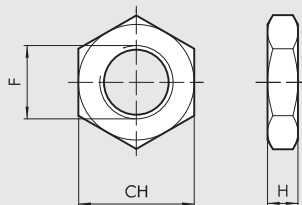

Code	Ø	F	H	CH	Weight [g]
0950322010	32	M10x1.25	6	17	6
0950502010	50	M16x1.5	8	24	20
0950502010	63	M16x1.5	8	24	20
0950502010	63 HD	M16x1.5	8	24	20
0950802010	80	M20x1.5	9	30	32
0950802010	100	M20x1.5	9	30	32

Note: Individually packed

FORK MODEL GK-M

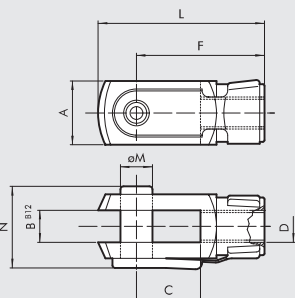

Code	Ø	øM	C	B	A	L	F	D	N	Weight [g]
W0950322020	32	10	20	10	20	52	40	M10x1.25	26	92
W0950502020	50	16	32	16	32	83	64	M16x1.5	40	340
W0950502020	63	16	32	16	32	83	64	M16x1.5	40	340
W0950502020	63 HD	16	32	16	32	83	64	M16x1.5	40	340
W0950802020	80	20	40	20	40	105	80	M20x1.5	40	690
W0950802020	100	20	40	20	40	105	80	M20x1.5	48	690

Note: Individually packed

ROD EYE - MODEL GA-M

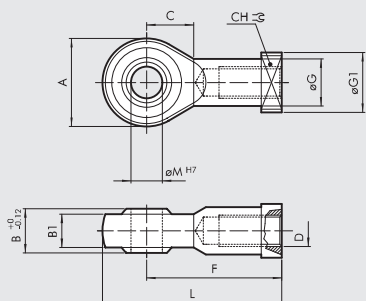

Code	Ø	øM	C	B1	B	A	L	F	D	øG	CH	øG1	Weight [g]
W0950322025	32	10	15	10.5	14	28	57	43	M10x1.25	15	17	19	78
W0950502025	50	16	22	15	21	42	85	64	M16x1.5	22	22	22	226
W0950502025	63	16	22	15	21	42	85	64	M16x1.5	22	22	22	226
W0950502025	63 HD	16	22	15	21	42	85	64	M16x1.5	22	22	22	226
W0950802025	80	20	26	18	25	50	102	77	M20x1.5	27.5	30	27	404
W0950802025	100	20	26	18	25	50	102	77	M20x1.5	27.5	30	27	404

Note: Individually packed

SELF ALIGNING ROD COUPLER - MODEL GA-K

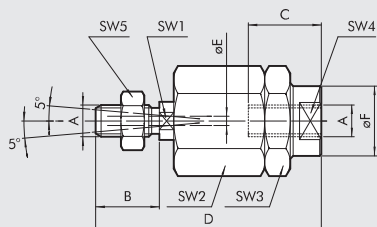

Code	Ø	A	B	C	D	øF	øE	SW1	SW2	SW3	SW4	SW5	Weight [g]
W0950322030	32	M10x1.25	20	20	71	22	4	12	30	30	19	17	216
W0950502030	50	M16x1.5	32	32	103	32	4	20	41	41	30	24	620
W0950502030	63	M16x1.5	32	32	103	32	4	20	41	41	30	24	620
W0950502030	63 HD	M16x1.5	32	32	103	32	4	20	41	41	30	24	620
W0950802030	80	M20x1.5	40	40	119	32	4	20	41	41	30	30	680
W0950802030	100	M20x1.5	40	40	119	32	4	20	41	41	30	30	680

Note: Individually packed

POSITION SENSORS

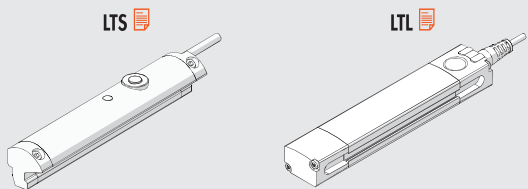

For technical data and usage strokes see chapter A6.

GUIDE UNIT

Version

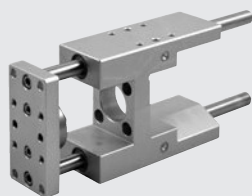

Sliding on bronze bushings (GDH)

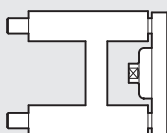

Code

Bore

Type

W0700322...	32*	UNIT MW DH 032...
W0700502...	50	UNIT MW DH 050...
W0700632...	63	UNIT MW DH 063...
W070E802...	80	UNIT MW DH 080...
W070EA12...	100	UNIT MW DH 100...

* Also available in V-Lock version (see chapter A3).

Note: The guide units must only be used with anti-rotation cylinders.

To complete the type and code, add the 3-digit stroke (e.g. 50=050)

For technical data and dimensions, see chapter A1.

Sliding on ball bearing (GDM)



W0700323...	32*	UNIT MW DM 032...
W0700503...	50	UNIT MW DM 050...
W0700633...	63	UNIT MW DM 063...
W070E803...	80	UNIT MW DM 080...
W070EA13...	100	UNIT MW DM 100...

* Also available in V-Lock version (see chapter A3).

Note: The guide units must only be used with anti-rotation cylinders.

To complete the type and code, add the 3-digit stroke (e.g. 50=050)

For technical data and dimensions, see chapter A1.

DRIVES



For motor-drive couplings see table on page A5.31

NOTES

SPARE PARTS

ELEKTRO ISO 15552 Ø 100 GEARBOX

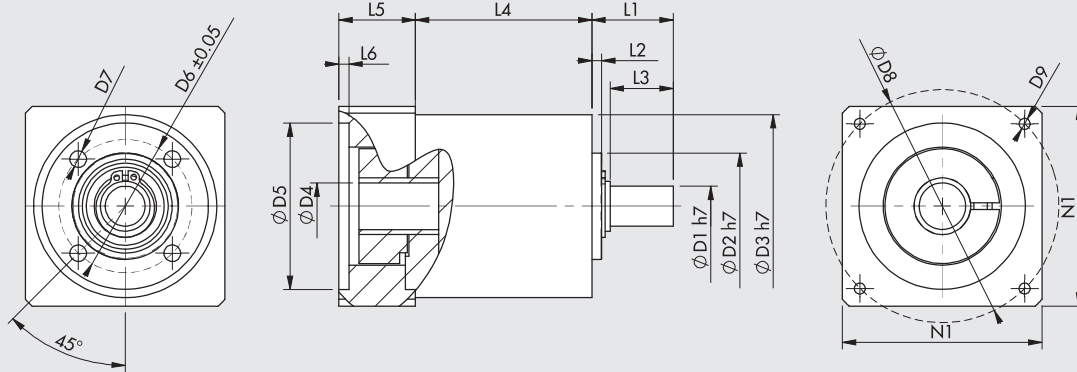

Code	Description	Application	C _{OUT} nominal [Nm]	N _{IN} nominal [1/min]	J reduced to motor shaft [kgmm ²]	Mass [kg]	D1	D2	D3	D4	D5	D6	D7	D8	D9	L1	L2	L3	L4	L5	L6	N1
37R0364000	Gearbox MP105 1:3	Elektro ISO 15552 Ø 100	100	2500	222	6.5	25	70	106	24	110	85	M8	145	M8x20	57.5	5	50.5	107.5	48	6.5	120

C_{out} = rated output torque

N_{in} = nominal input speed

J = mass moment of inertia of the gearhead

ELECTRIC MOTORS



For motor-drive couplings see table on page A5.31

NOTES

ELECTRIC CYLINDER SERIES ELEKTRO ISO 15552 EK

An electric cylinder with a connection interface in accordance with ISO 15552.

The ELEKTRO ISO 15552 EK series stands out for some design choices that made it possible to reduce the length and cut costs, with a few different technical characteristics.

The piston rod moves forward by means of either a hardened and tempered screw and a ball recirculating screw nut or a trapezoidal screw (acme) and bronze bushing.

The cylinder comes with a built-in anti-rotation system obtained with two technopolymer pads that slide in the liner along two longitudinal grooves.

The piston has a magnet and the liner has slots that accommodate magnetic sensors.

A greasing system is incorporated to lubricate the screw/ball screw nut.

Only a version with inline motor, which is shorter than the equivalent ELEKTRO ISO15552 cylinder, is provided. The version with geared motors is available on specific request.

A steel bracket to be fixed to the rear head, with an interface suitable for ISO 15552 cylinder accessories, is provided to be fixed to the cylinder from the rear side.

The cylinder can be supplied with a STEPPING or a BRUSHLESS motor, with or without parking brake.

Cylinders with a flange suitable for a motor brand that is most liked by the customer are available on request.

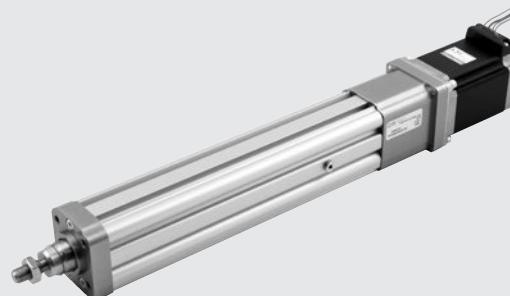

TECHNICAL DATA		Ø 32
Piston rod thread	mm	M10x1.25
Environmental temperature range for STEPPING motors	°C	from -10 to +50
BRUSHLESS motors	°C	from 0 to +40
Electrical protection rating with motors		IP40
Minimum stroke		Twice the screw pitch (to guarantee ball lubrication)
Maximum stroke	mm	500
Positioning repeatability	mm	± 0.02 with screw/ball screw nut; ± 0.15 with trapezoidal screw (acme)
Positioning accuracy	mm	± 0.2 **
Overall radial oscillation of the piston rod (without load) for 100 mm of stroke	mm	0.4
Versions		Ball screw; trapezoidal screw (acme) with bronze bushing
Anti-rotation of the piston rod		YES
Maximum angle of twist of the piston rod		1°30'
Motor layout		In line with piston rod axis
Uncontrolled impact at the end of stroke		NOT ALLOWED (it provides an extra-stroke minimum 5 mm)
Sensor magnet		YES
Work position		Any

** indicative average data that gets influenced by various factors such as the stroke, the type of motor, the cylinder version, etc ...

MECHANICAL FEATURES		Ball screw		Trapezoidal screw (acme) with bronze bushing
Screw pitch (p)	mm	4	10	4
Screw diameter	mm	12	12	14
Static axial load (F _o)*	N	3000	3000	3000
Dynamic axial load (F)	N	5200	3160	see graph force/speed
		Calculate mean axial load and the calculate life (see graphs on page A5.43)		N.B: 40% duty cycle, i.e. the cylinder must work maximum 40% of time to allow the screw/ball screw nut to cool down.
Maximum number of revs	1/min	3000	3000	750
Maximum speed (V _{max})	mm/s	200	500	50
"K" ratio of motor revs and piston rod speed	n/V	15	6	15

Example: V = 100 mm/s; pitch = 10 → K=6 n= V x K = 100 x 6 = 600 rpm

* **N.B.:** Static loads bearable without damage. Payloads are shown in the diagrams on page A5.44 onwards.

WEIGHTS (ONLY CYLINDER)		Ball screw		Trapezoidal screw (acme) with bronze bushing
Screw pitch (p)	mm	4	10	4
Weight at stroke 0, without motor	g	610	620	720
Additional weight each mm of stroke	g	4.3	4.3	4.3
Moving mass at stroke 0 (Mx)	g	189.4	189.4	209.4
Additional moving mass each mm of stroke	g	1.3	1.3	1.3

N.B.: You get the total weight of a complete cylinder by adding: weight stroke 0 + stroke [mm] x weight for each mm of stroke + weight of the motor.

MASS MOMENTS OF INERTIA		Ball screw		Trapezoidal screw (acme) with bronze bushing
Screw pitch	mm	4	10	4
J0 at stroke 0	kgmm ²	9.9849	10.0979	10.2979
J1 each metre of stroke	kgmm ² /m	12.76	13.76	16.81
J2 each kg of load	kgmm ² /kg	0.4053	2.533	0.4053

The total mass moment of inertia (Jtot) reduced for the motor is: Jtot = J0 + J1 · stroke [m] + J2 · (load [kg] + Mx [kg])
Mx is defined in the weights table.

CALCULATION OF MEAN AXIAL LOAD F_m AND VERIFICATION

Peak axial load in a work cycle must not exceed the static axial load F_o.
The peak value is usually achieved during upward acceleration in vertical installation. Exceeding this value leads to greater wear and hence shorter life of the recirculating ball screw.

Mean axial load F_m

$$F_m = \sqrt[3]{\sum F_x^3 \times \frac{V_x}{V_m} \times \frac{q}{100}} =$$

$$F_m = \sqrt[3]{F_{x1}^3 \times \frac{V_{x1}}{V_m} \times \frac{q_1}{100} + F_{x2}^3 \times \frac{V_{x2}}{V_m} \times \frac{q_2}{100} + F_{x3}^3 \times \frac{V_{x3}}{V_m} \times \frac{q_3}{100} + \dots}$$

- F_x = Axial load at stage x
- F_m = Mean axial load during extension
- F_o = Static axial load
- q = Time segment
- V_x = Speed in the phase x
- V_m = Average speed

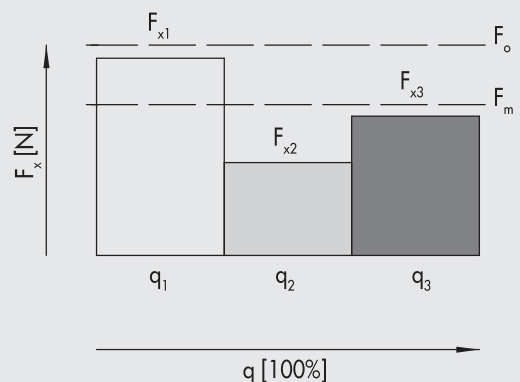

The mean axial load must not exceed the dynamic axial load: F_m ≤ F_d
The graphs on page A5.44 show screw life as a function of F_m

COMPONENTS

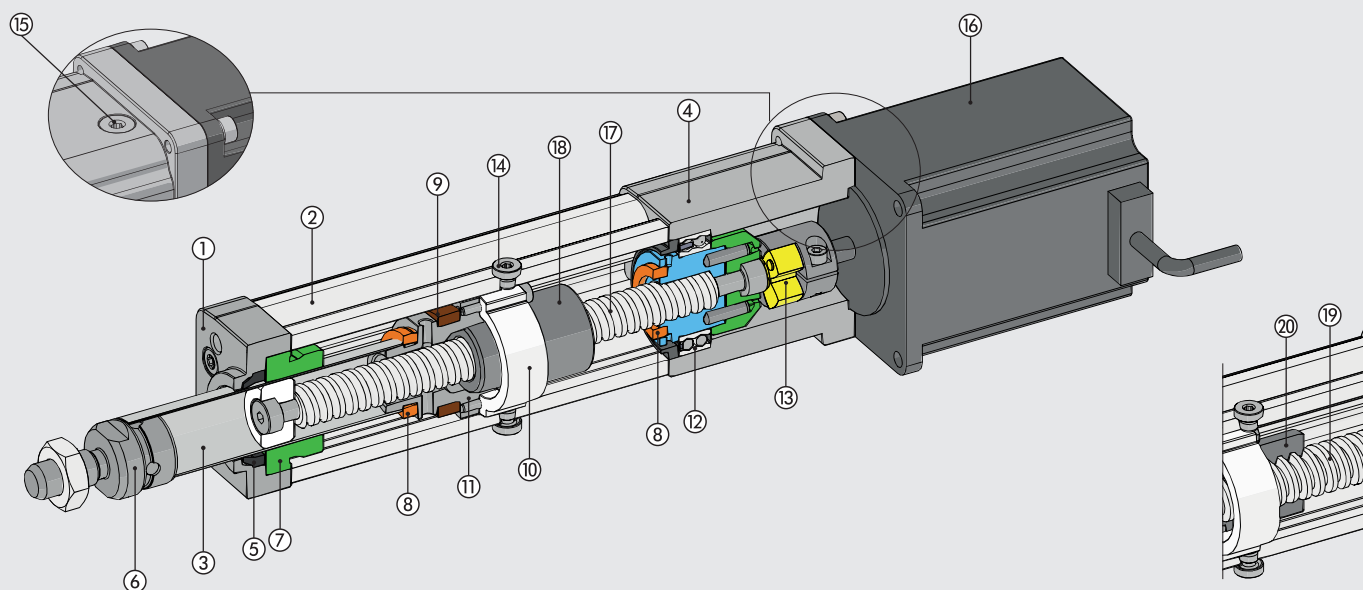

- ① FRONT CYLINDER HEAD: anodized aluminium
- ② BARREL: extruded and anodized aluminium alloy
- ③ PISTON ROD: stainless steel pipe
- ④ REAR CYLINDER HEAD: anodized aluminium
- ⑤ WIPER RING: polyurethane
- ⑥ NIPPLE: stainless steel
- ⑦ GUIDE BUSHING: technopolymer
- ⑧ BUFFER: polyurethane
- ⑨ MAGNET: plastroferrite
- ⑩ GUIDE AND ANTI-ROTATION RING: technopolymer
- ⑪ PISTON: aluminium
- ⑫ BEARING: oblique with two ball rings

- ⑬ ELASTIC COUPLING: aluminium / polyurethane
- ⑭ PLUG: remove it to insert the greaser
- ⑮ PLUG: for access to the elastic coupling screw
- ⑯ ELECTRIC MOTOR

Version with ball screw:

- ⑰ SCREW: hardened and rolled steel
- ⑱ NUT: ball recirculating

Version with trapezoidal screw (acme):

- ⑲ TRAPEZOIDAL SCREW (ACME): steel
- ⑳ NUT: bronze

FIXING OPTIONS

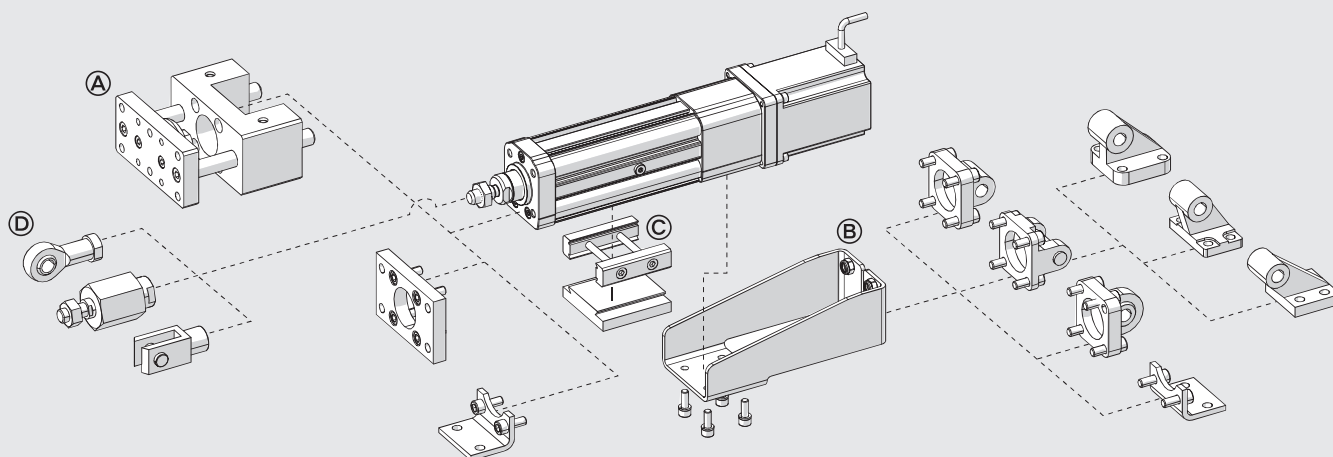

- Ⓐ Fixing on the front head with 4 threaded holes according to ISO 15552 standard.
- Ⓑ Fixing on the rear side, using the "rear fixing bracket". ISO 15552 accessories can be fitted onto this bracket.
- Ⓒ Fixing on one side of the liner, using QS fixing elements. See page A3.15
- Ⓓ Piston rod accessories.

PEAK LOADS

With vertical installations, the following load conditions applied to the piston rod must be met.

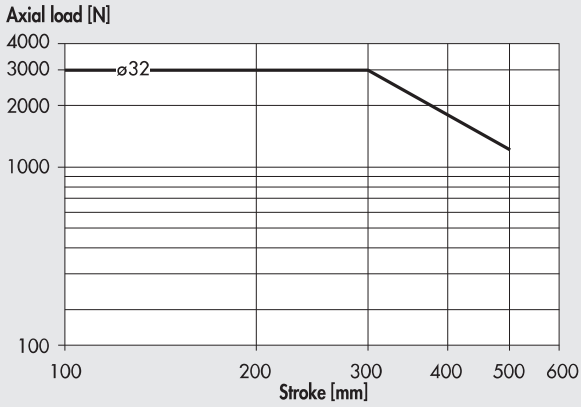

MAXIMUM RADIAL LOADS ON PISTON ROD

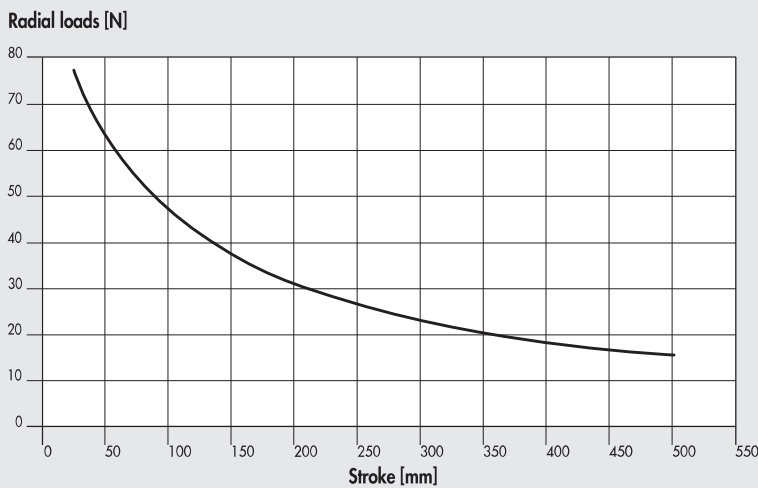

Radial loads can be applied to the piston rod. They must not exceed the values in the adjacent chart, otherwise the guides on the rod and piston will be subjected to excessive wear.

LIFE CHARACTERISTICS AS A FUNCTION OF THE MEAN AXIAL LOAD, BALL SCREW VERSION

Life characteristics can vary considerably from those indicated in the graphs due to different operating conditions (radial loads, temperature, lubrication status, etc.).

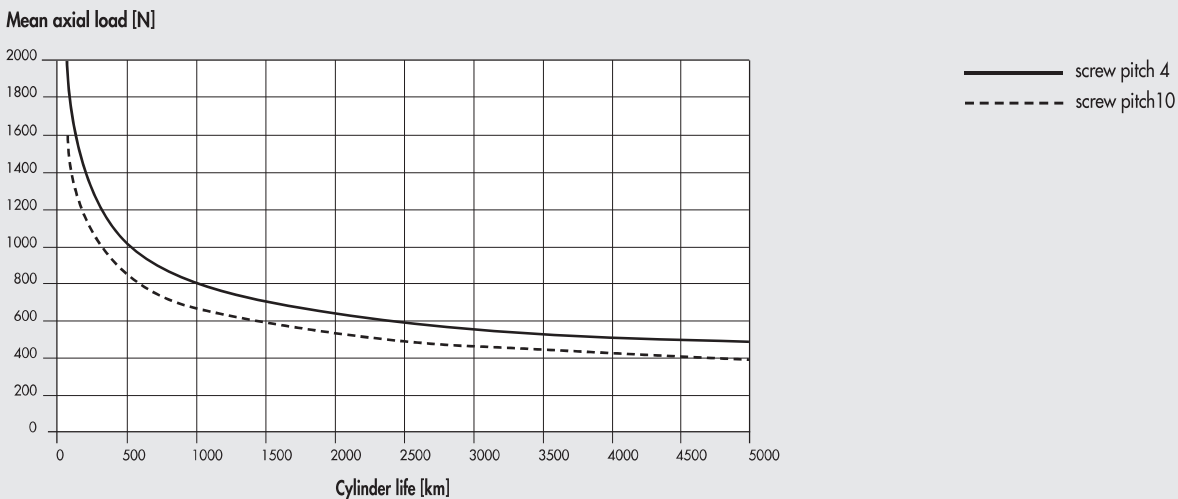

MAX. FORCE/SPEED CHART FOR VERSION WITH TRAPEZOIDAL SCREW (ACME) WITH BRONZE BUSHING

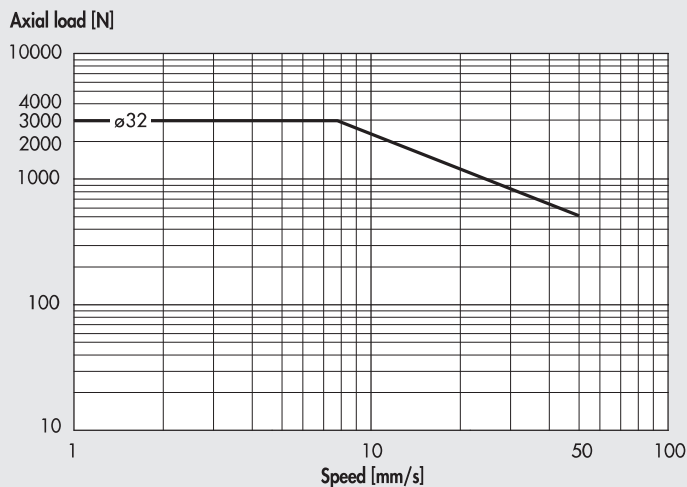

To prevent the bushing from excessive wear and tear, it is recommended to work below the curve indicated.

AXIAL LOAD CURVES AS A FUNCTION OF SPEED (CYLINDER COMPLETE WITH MOTOR AND DRIVE)

N.B.: The obtainable load values already take the efficiency of the system into account. For STEPPING motors, with the motor off, the drive current is automatically reduced by 50% to prevent overheating. Consequently, available axial load with the motor stopped is also reduced by 50%.

Ø 32 with pitch 4 ball screw, STEPPING motor and STEPPING motor with brake

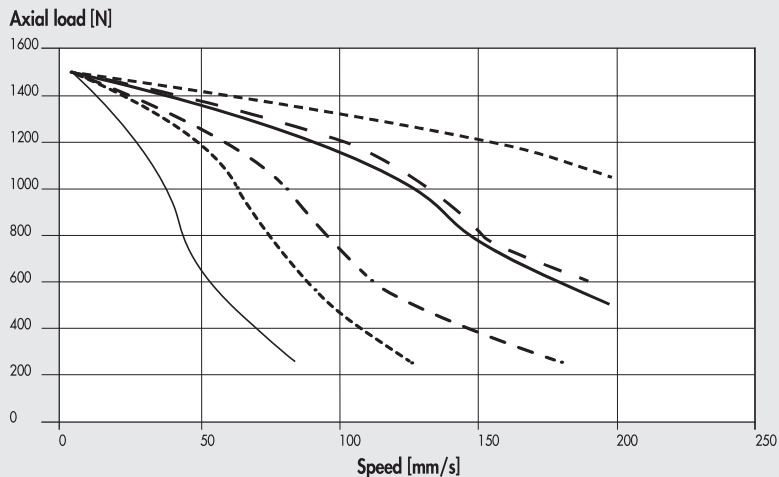

- 37M5120000 (with brake, 24VDC)
- - - - 37M5120000 (with brake, 48VDC)
- 37M5120000 (with brake, 75VDC)
- - - - 37M1120001 (24VDC)
- - - - 37M1120001 (48VDC)
- - - - 37M1120001 (75VDC)

Ø 32 with pitch 10 ball screw, STEPPING motor and STEPPING motor with brake

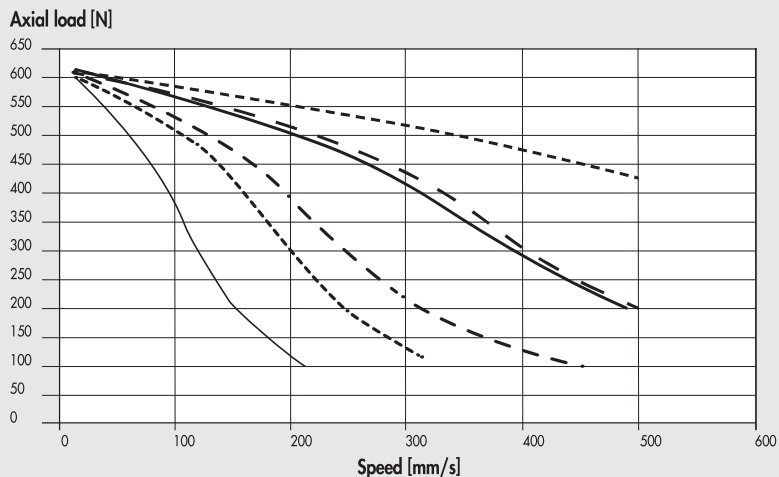

- 37M5120000 (with brake, 24VDC)
- - - - 37M5120000 with brake, 48VDC)
- 37M5120000 (with brake, 75VDC)
- - - - 37M1120001 (24VDC)
- - - - 37M1120001 (48VDC)
- - - - 37M1120001 (75VDC)

Ø 32 with pitch 4 ball screw, BRUSHLESS motor and BRUSHLESS motor with brake

Axial load [N]

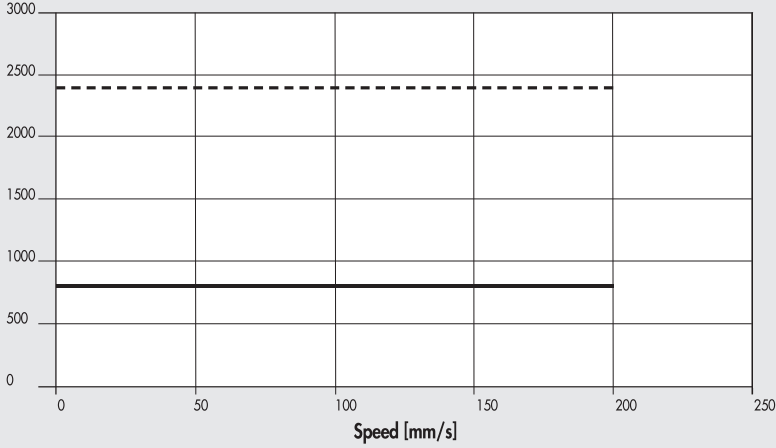

- Nominal 37M2200001 or 37M4200001 (with brake) + 37D2200001 (200W)
- - - Maximum 37M2200001 or 37M4200001 (with brake) + 37D2200001 (200W)

Ø 32 with pitch 10 ball screw, BRUSHLESS motor and BRUSHLESS motor with brake

Axial load [N]

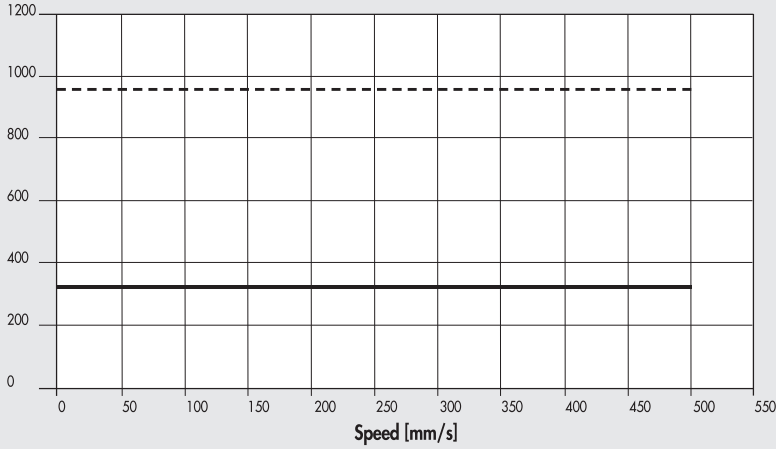

- Nominal 37M2200001 or 37M4200001 (with brake) + 37D2200001 (200W)
- - - Maximum 37M2200001 or 37M4200001 (with brake) + 37D2200001 (200W)

Ø 32 with pitch 4 trapezoidal screw (acme), STEPPING motor

Axial load [N]

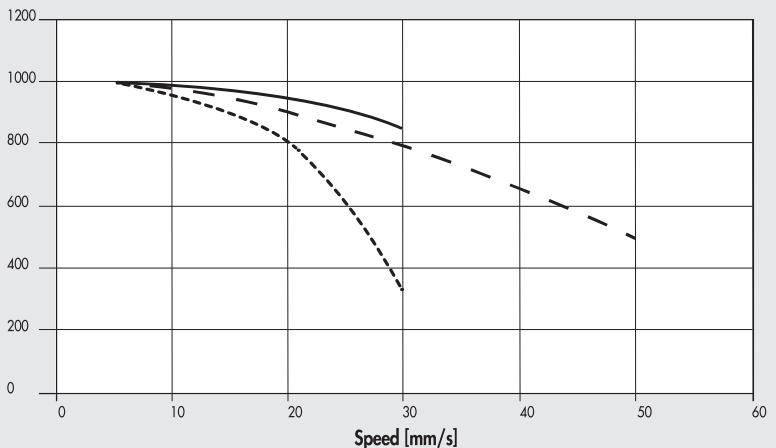

- - - 37M1230000 (24VDC)
- - - 37M1230000 (48VDC)
- 37M1230000 (75VDC)

DIMENSIONS

WITHOUT MOTOR

- + = Add the stroke
- ① = Slots for sensors
- ② = Slots for anti-rotation
- ③ = Dovetail for QS fixing
- ④ = Threaded holes for fixing brackets with ISO 15552 accessories
- ⑤ = Lubricator port

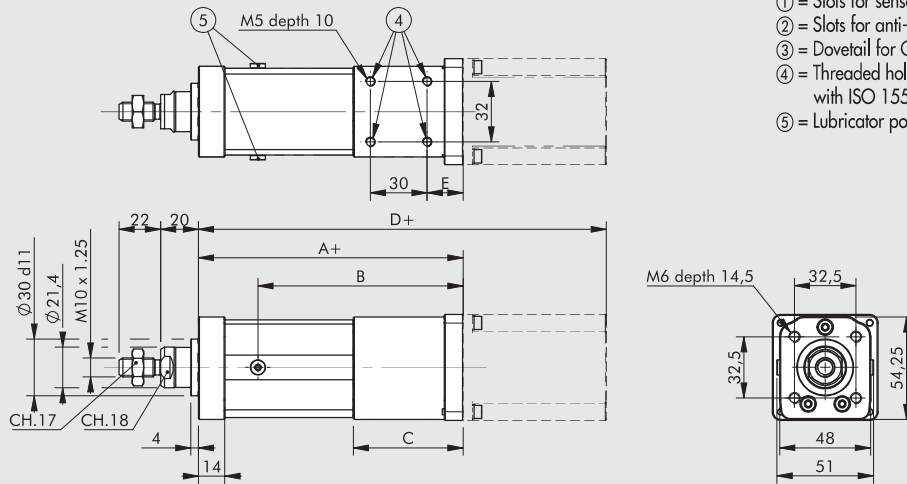
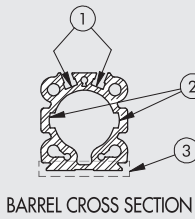

WITH MOTOR

Overall dimensions for standard drive

STEPPING MOTOR code 37M1120001					STEPPING MOTOR code 37M1230000					BRUSHLESS MOTOR code 37M2200001					STEPPING MOTORE WITH BRAKE WITHOUT ENCODER code 37M5120000					BRUSHLESS MOTOR WITH BRAKE code 37M4200001				
A	B	C	D	E	A	B	C	D	E	A	B	C	D	E	A	B	C	D	E	A	B	C	D	E
140	108.5	58	215.8	19	141	109.5	59	226.8	20	150.5	119	68.5	256	20	140	108.5	58	251.8	19	150.5	119	68.5	292.1	20

NOTES

ACCESSORIES FOR ELECTRIC CYLINDER SERIES ELEKTRO ISO 15552 EK

Note: Where specified, limit the maximum axial loads (F_{max}) according to the electric cylinders

FIXING ELEMENTS QS

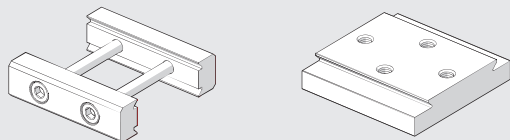

See V-Lock family.

BRACKET FOR REAR FIXING

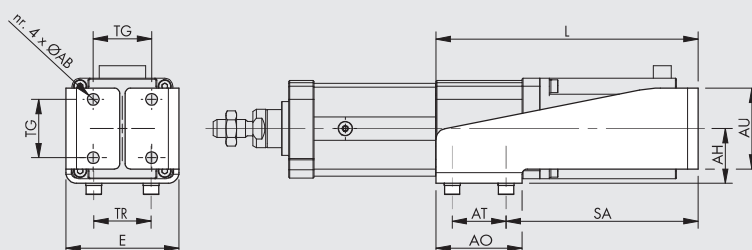

STEEL

Code	Ø	ØAB	TG	TR	E	AT	SA	AO	AU	AH	L	Weight [g]	F_{max} [N]
0950327090	32	6.5	32.5	32	63	30	107	48	45	30.5	146	375	1600
0950327091	32	6.5	32.5	32	67	30	144.5	48	45	30.5	183.5	445	1600

Note: Supplied complete with 4 screws and 4 washers for fixing to the cylinder, 4 self-locking nuts and 4 screws for fixing the anchor clamp.

N.B.: Code 0950327090 can be used with motor 37M1120001.

Code 0950327091 can be used with motors 37M2200001, 37M1230000 and 37M5120000.

A bracket suitable for motor 37M4200001 is not provided.

FOOT MODEL A

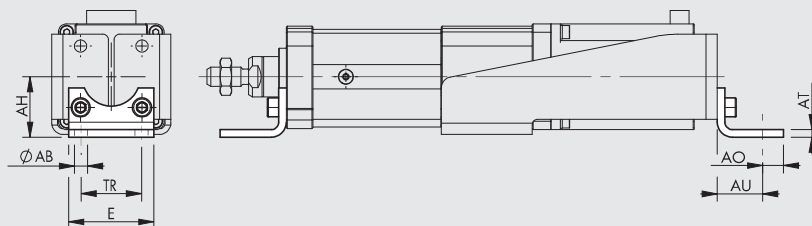

STEEL

Code	Ø	ØAB	AH	AO	AT	AU	TR	E	Weight [g]	F_{max} [N]
W0950322001	32	7	32	11	4	24	32	45	76	1600

Note: Individually packed with 2 screws.

FEMALE HINGE - MODEL B

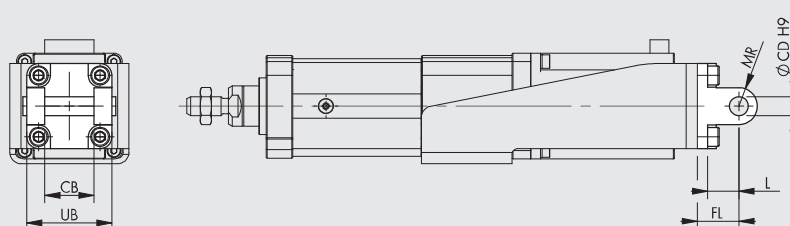

ALUMINIUM

Code	Ø	UB	CB	FL	ØCD	MR	L	Weight [g]	F_{max} [N]
W0950322003	32	45	26	22	10	10	12	116	800

Note: Supplied with 4 screws, 4 washers, 2 snap rings and 1 pin.

STEEL

Code	Ø	UB	CB	FL	ØCD	MR	L	Weight [g]	F_{max} [N]
W095E322003	32	45	26	22	10	10	13	348	1600

Note: Supplied with 4 screws, 4 washers, 2 snap rings and 1 pin.

MALE HINGE - MODEL BA

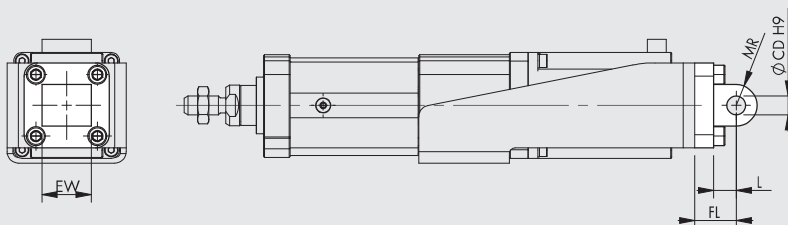

ALUMINIUM

Code	Ø	EW	FL	MR	ØCD	L	Weight [g]	Fmax [N]
W0950322004	32	26	22	10	10	13	94	800

Note: Supplied with 4 screws.

STEEL

Code	Ø	EW	FL	MR	ØCD	L	Weight [g]	Fmax [N]
W095E322004	32	26	22	10	10	13	282	1600

Note: Supplied with 4 screws.

ARTICULATED MALE HINGE - MODEL BAS

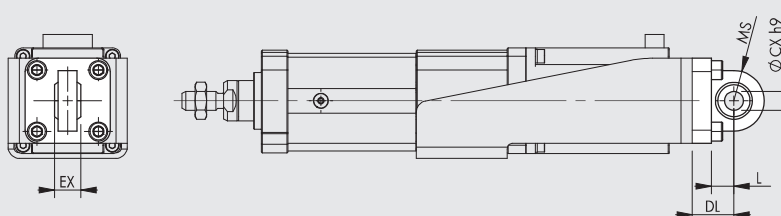

ALUMINIUM

Code	Ø	DL	MS	L	ØCX	EX	Weight [g]	Fmax [N]
W0950322006	32	22	16	12	10	14	106	800

Note: Supplied with 4 screws, 4 washers.

STEEL

Code	Ø	DL	MS	L	ØCX	EX	Weight [g]	Fmax [N]
W095E322006	32	22	15	14	10	14	318	1600

Note: Supplied with 4 screws, 4 washers.

CETOP HINGE FOR MODEL B - MODEL GI

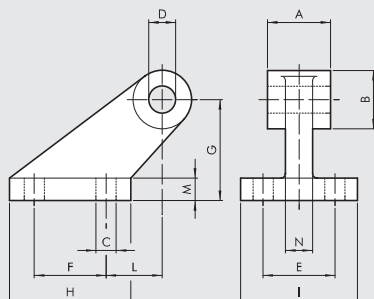

ALUMINIUM

Code	Ø	A	B	C	D	E	F	G	H	I	L	M	N	Weight [g]	Fmax [N]
W0950322008	32	26	19	7	10	25	20	32	37	41	18	8	10	96	800

Note: Supplied with 4 screws, 4 washers.

COUNTER-HINGE FOR MODEL B - MODEL GS

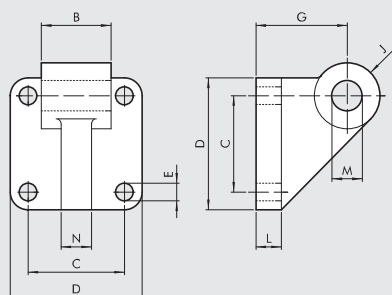

ALUMINIUM

Code	Ø	B	C	D	E	G	J	L	M	N	Weight [g]	Fmax [N]
W0950322108	32	26	32.5	45	7	32	11	10	10	10	106	800

Note: Supplied with 4 screws, 4 washers.

ISO 15552 COUNTER-HINGE FOR MODEL B - MODEL AB7

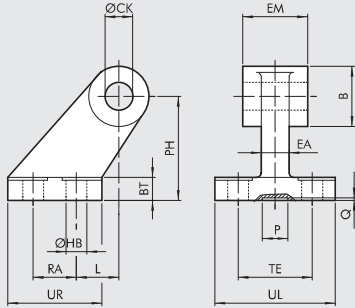

ALUMINIUM

Code	Ø	EM	B	ØHB	ØCK	TE	RA	PH	UR	UL	L	BT	EA	P	Q	Weight [g]	Fmax [N]
W0950322017	32	26	20	6.6	10	38	18	32	31	51	3	8	10	21	3	60	800

STEEL

Code	Ø	EM	B	ØHB	ØCK	TE	RA	PH	UR	UL	L	BT	EA	P	Q	Weight [g]	Fmax [N]
W095E322017	32	26	20	6.6	10	38	18	32	31	51	3	8	10	20	5	180	1600

FRONT FLANGE - MODEL C

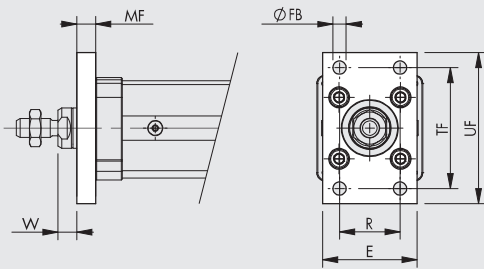

Code	Ø	TF	UF	E	MF	R	ØFB	W	Weight [g]	Fmax [N]
W0950322002	32	64	80	50	10	32	7	16	246	1600

Note: Supplied with 4 screws.

ROD NUT - MODEL S

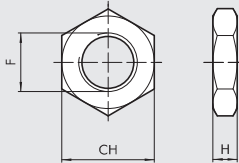

Code	Ø	F	H	CH	Weight [g]
0950322010	32	M10x1.25	6	17	6

Note: Individually packed

FORK MODEL GK-M

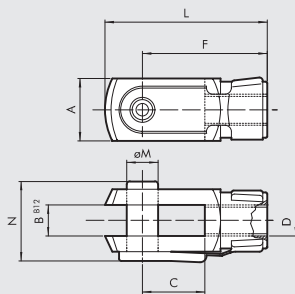

Code	Ø	øM	C	B	A	L	F	D	N	Weight [g]
W0950322020	32	10	20	10	20	52	40	M10x1.25	26	92

Note: Individually packed

ROD EYE - MODEL GA-M

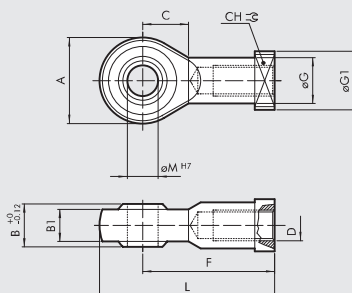

Code	Ø	øM	C	B1	B	A	L	F	D	øG	CH	øG1	Weight [g]
W0950322025	32	10	15	10.5	14	28	57	43	M10x1.25	15	17	19	78

Note: Individually packed

SELF ALIGNING ROD COUPLER - MODEL GA-K

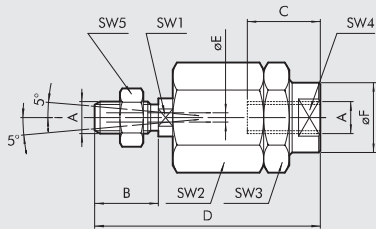

Code	Ø	A	B	C	D	øF	øE	SW1	SW2	SW3	SW4	SW5	Weight [g]
W0950322030	32	M10x1.25	20	20	71	22	4	12	30	30	19	17	216

Note: Individually packed

GREASING NEEDLE

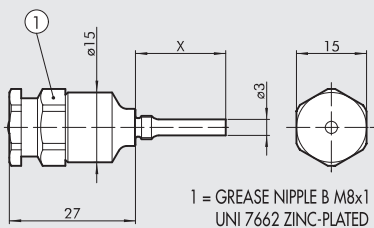

Code	Ø	X
0950327108	32	12

Note: Individually packed

GREASE

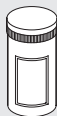

Code	Description	Weight [g]
9910506	Tube of RHEOLUBE 363 AX1 grease	400

RETRACTABLE SENSOR

SENSOR, SQUARE TYPE 
Latest generation,
secure fixing

SENSOR, OVAL TYPE 
Traditional

For codes and technical data, see [chapter A6](#).

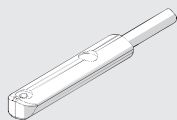
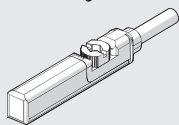

POSITION SENSORS

LTS

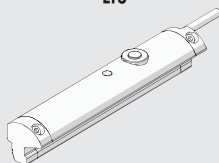

For technical data and usage strokes see [chapter A6](#). 

NOTES

GUIDE UNIT

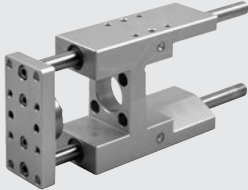
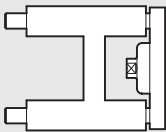
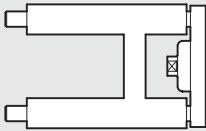
Version		Code	Bore	Type
	Sliding on bronze bushings (GDH)	W0700322...	32	UNIT MW DH 032...
		<p>Note: The guide units must only be used with anti-rotation cylinders. To complete the type and code, add the 3-digit stroke (e.g. 50=050) For technical data and dimensions, see chapter A1.</p>		
	Sliding on ball bearing (GDM)	W0700323...	32	UNIT MW DM 032...
		<p>Note: The guide units must only be used with anti-rotation cylinders. To complete the type and code, add the 3-digit stroke (e.g. 50=050). For technical data and dimensions, see chapter A1.</p>		

DRIVES



For motor-drive couplings see table on page A5.48 

SPARE PARTS

ELECTRIC MOTORS



For motor-drive couplings see table on page A5.48 

NOTES