

1

2

3

4

5

6

RevNo

Revision note

Date

Signature

Checked

A

A

AT5 Pulley with 40 Teeth
Designed for use with
10mm wide belts

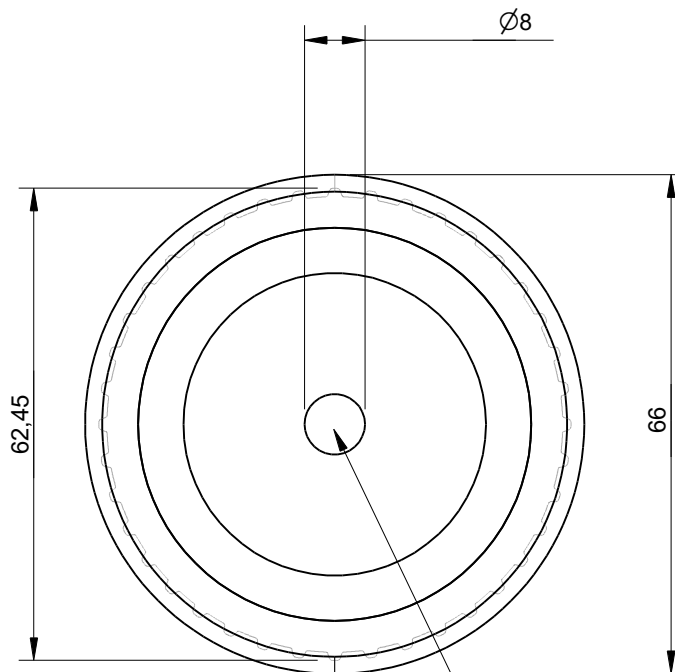
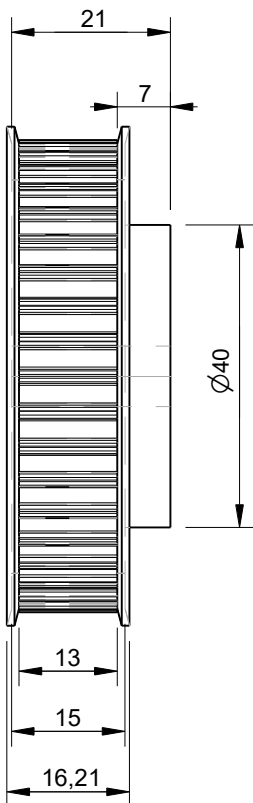
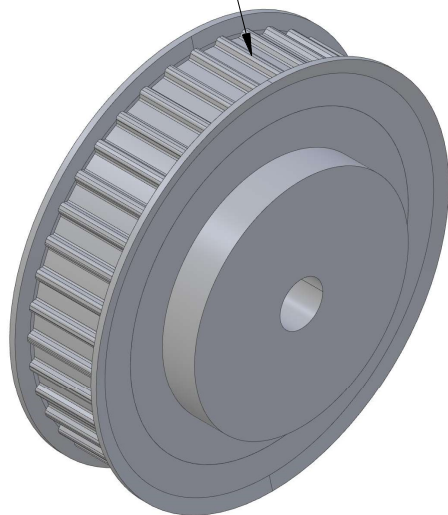

This AT5 pulley size
has a bore of 8mm

B

B

C

C

Effective (Outer) Diameter	62.45mm
Pitch Diameter	63.65mm
Weight	0.14kg
With Flanges?	yes
Material	Aluminium
Units	mm
Tolerances	+/-0.1mm

Itemref	Quantity	Title/Name, designation, material, dimension etc			Article No./Reference	
Drawn by Kevin Damen	Checked by	Approved by - date	File name	Date 30-1-2024	Scale 1:1	

6576

www.damencnc.com

6576 AT5 Pulley 21-AT5 Z=40
for 10mm wide belts

Edition

Sheet

1 OF 1

1

2

3

4

5

6

D

D