

1

2

3

4

5

6

RevNo	Revision note		Date	Signature	Checked
-------	---------------	--	------	-----------	---------

A

A

AT5 Pulley with 42 Teeth
Designed for use with
10mm wide belts

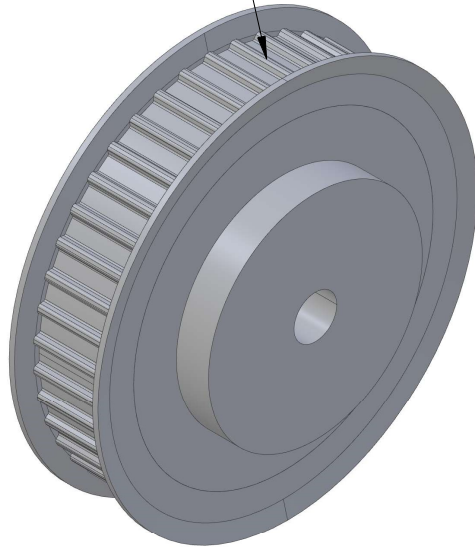

B

B

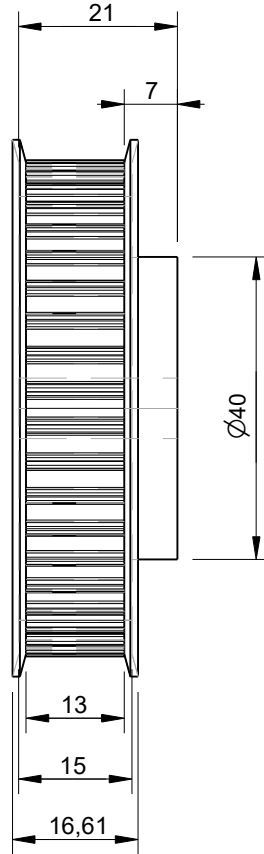

C

C

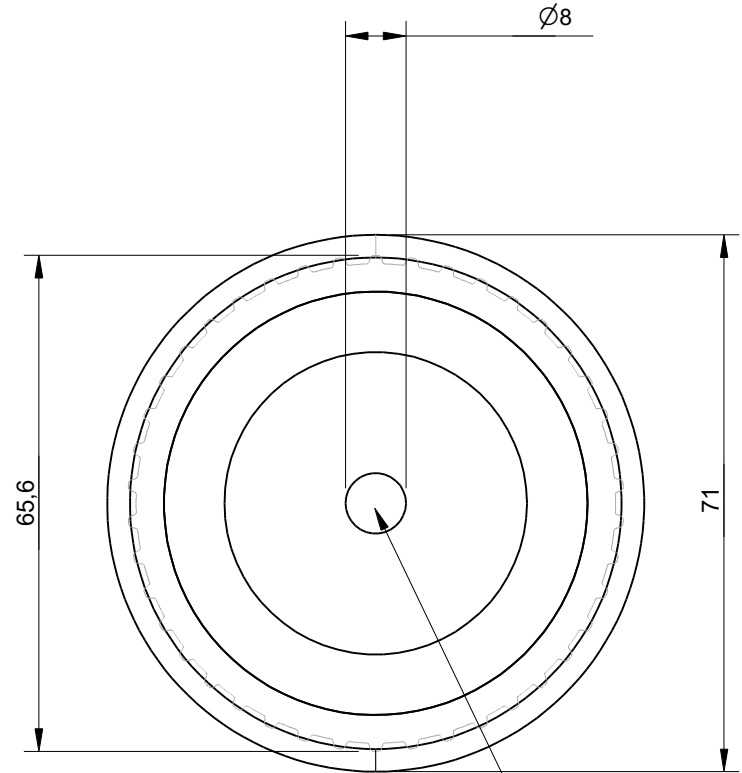

This AT5 pulley size
has a bore of 8mm

D

D

Effective (Outer) Diameter	65.60mm
Pitch Diameter	66.80mm
Weight	0.18kg
With Flanges?	yes
Material	Aluminium
Units	mm
Tolerances	+/-0.1mm

Itemref	Quantity	Title/Name, designation, material, dimension etc			Article No./Reference	
Drawn by Kevin Damen	Checked by	Approved by - date	File name	Date 30-1-2024	Scale 1:1	

6577

www.damencnc.com

6577 AT5 Pulley 21-AT5 Z=42 for 10mm wide belts	Edition	Sheet 1 OF 1
--	---------	-----------------

1

2

3

4

5

6