

1

2

3

4

5

6

RevNo Revision note

Date

Signature

Checked

A

A

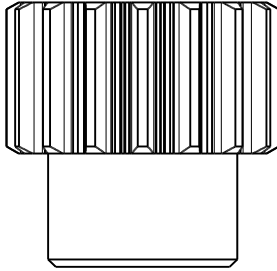
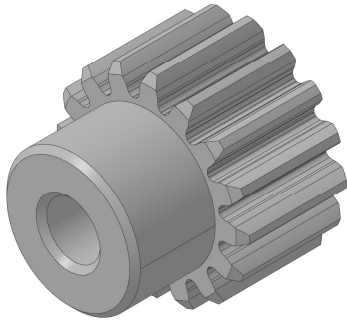

B

B

C

C

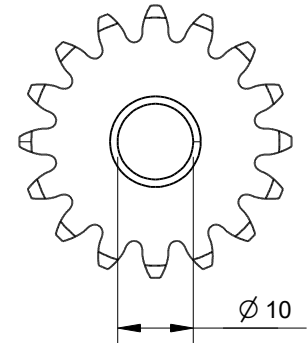
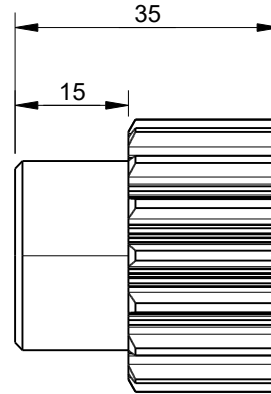
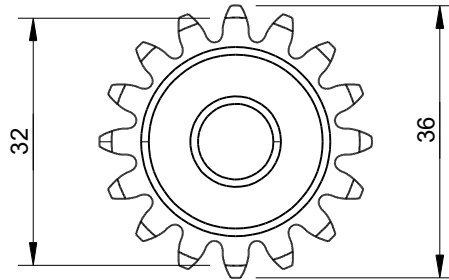
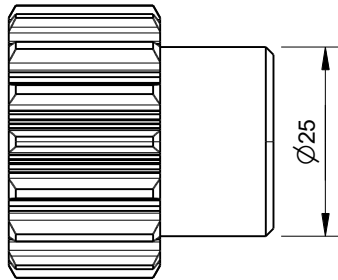

D

D

Number of Teeth (Z)	16
Module	2
Pressure Angle	20°
Outside Ø	36
Pitch Ø	32
Root Ø	27
Bore Ø	10
Material	Steel C45
Units	mm
Tolerances	+/- 0.1mm unless otherwise specified

Itemref	Quantity	Title/Name, designation, material, dimension etc			Article No./Reference	
Drawn by Kevin Damen		Checked by	Approved by - date	File name	Date 1-7-2024	Scale 1:1

6881

www.damencnc.com

6881 Module 2 Gear, with 16 teeth

Edition	Sheet
	1 OF 1

1

2

3

4

5

6