

SACC-M12MSD-4PL SH PN - Connector



1424682

<https://www.phoenixcontact.com/nl/producten/1424682>

Please be informed that the data shown in this PDF document is generated from our online catalog. Please find the complete data in the user documentation. Our general terms of use for downloads are valid.



Connector, PROFINET CAT5 (100 Mbps), 4-position, shielded, Plug straight M12, coding: D, Push-lock spring connection, knurl material: Zinc die-cast, nickel-plated, external cable diameter 4 mm ... 8 mm

Your advantages

- Time-saving Push-Lock connection: Tool-free connection and disconnection of conductors by opening the contact levers
- Intuitive connection: Easy assignment of individual litz wires with color-coded and numerical identification of the contact levers
- Integrated Push-in Technology: Wire rigid and pretreated conductors easily by means of simple, direct insertion
- Shock- and vibration-resistant connection: Proven spring-cage technology guarantees secure and reliable contacting

Commercial data

Item number	1424682
Packing unit	1 pc
Minimum order quantity	1 pc
Sales key	BF2CFN
Product key	BF2CFN
Catalog page	Page 343 (C-2-2019)
GTIN	4055626376097
Weight per piece (including packing)	36,6 g
Weight per piece (excluding packing)	37,5 g
Customs tariff number	85366990
Country of origin	DE

SACC-M12MSD-4PL SH PN - Connector



1424682

<https://www.phoenixcontact.com/nl/producten/1424682>

Technical data

Notes

Assembly note	NOTE: Observe the permissible bending radii when routing cables, since the degree of protection may be at risk if the bending forces are too high. Reduce mechanical loads upstream of the connector, e.g., by using cable ties.
Assembly note	NOTE: Observe the permissible bending radii when routing cables, since the degree of protection may be at risk if the bending forces are too high. Reduce mechanical loads upstream of the connector, e.g., by using cable ties.

Mounting

Assembly note	The wires can be connected both with ferrules and without ferrules
---------------	--

Product properties

Product type	Circular connector (cable-side)
Application	Data
Sensor type	PROFINET
Number of positions	4
No. of cable outlets	1
Shielded	yes
Coding	D
Cable outlet	straight

Data management status

Article revision	06
------------------	----

Insulation characteristics

Overvoltage category	II
Degree of pollution	3

Dimensions

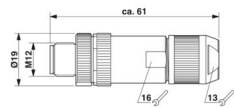
Dimensional drawing	
Length	60 mm

External dimensions

Outside diameter	4 mm ... 8 mm
------------------	---------------

Housing

Diameter housing	19 mm
------------------	-------

SACC-M12MSD-4PL SH PN - Connector



1424682

<https://www.phoenixcontact.com/nl/producten/1424682>

Material specifications

Material	TPE-U (Clamping cage, weight: 1.1 g) PA 6 (Actuation lever)
Flammability rating according to UL 94	V0
Seal material	NBR
Material of grip body	Zinc die-cast, nickel-plated
Contact material	CuSn
Contact surface material	Ni/Au
Contact carrier material	PA 6.6
Material for screw connection	Zinc die-cast, nickel-plated
Standards/regulations	PA 6.6: Fire protection in rail vehicles - requirement sets R22, R23, R24, R25, and R26 acc. to DIN EN 45545-2 (Risk level HL1 - HL3) PA 6: Fire protection in rail vehicles - requirement sets R22, R23, and R24 acc. to DIN EN 45545-2 (Risk level HL1 - HL3)

Connection data

Conductor connection

Connection method	Push-lock spring connection
Connection cross section	0.14 mm ² ... 0.75 mm ² (without ferrule) 0.08 mm ² ... 0.5 mm ² (with ferrule) 0.14 mm ² ... 0.75 mm ² (solid)
Connection cross section AWG	26 ... 18 (without ferrule) 28 ... 20 (with ferrule)
Stripping length of the individual wire	7 mm
Tightening torque	0.4 Nm (M12 knurl) 0.8 Nm (Connector with coupling sleeve) 3 Nm (Pressure nut with coupling sleeve)

Pin assignment

Contact Color (signal designation) Contact (optional)	1 = YE (TD+) 2 = WH (RD+) 3 = OG (TD-) 4 = BU (RD-)
---	--

Electrical properties

Rated surge voltage	1.5 kV
Contact resistance	≤ 5 mΩ
Insulation resistance	≥ 100 MΩ
Nominal voltage U _N	48 V AC 60 V DC
Nominal current I _N	4 A (2 A when using 0.14 mm ² conductors)

Mechanical properties

SACC-M12MSD-4PL SH PN - Connector



1424682

<https://www.phoenixcontact.com/nl/producten/1424682>

Mechanical data

Insertion/withdrawal cycles	≥ 100 (Quantity: 500 with Phoenix Contact mating connector)
-----------------------------	---

Connector

Connection 1

Head design	Plug
Head cable outlet	straight
Head thread type	M12
Coding	D

Cable/line

Signal type/category	PROFINET CAT5 (based on IEC 11801), 100 Mbps
Stripping length of the individual wire	7 mm

Environmental and real-life conditions

Ambient conditions

Degree of protection	IP65
	IP67
Ambient temperature (operation)	-40 °C ... 85 °C (Plug / socket)

Standards and regulations

Testing

Standards/regulations	PA 6.6: Fire protection in rail vehicles - requirement sets R22, R23, R24, R25, and R26 acc. to DIN EN 45545-2 (Risk level HL1 - HL3)
	PA 6: Fire protection in rail vehicles - requirement sets R22, R23, and R24 acc. to DIN EN 45545-2 (Risk level HL1 - HL3)

M12

Standard designation	M12 connector
Standards/specifications	IEC 61076-2-101
Standard designation	Shock, vibration
Standards/specifications	EN 50155:2001

SACC-M12MSD-4PL SH PN - Connector

1424682

<https://www.phoenixcontact.com/nl/producten/1424682>

Drawings

Schematic diagram

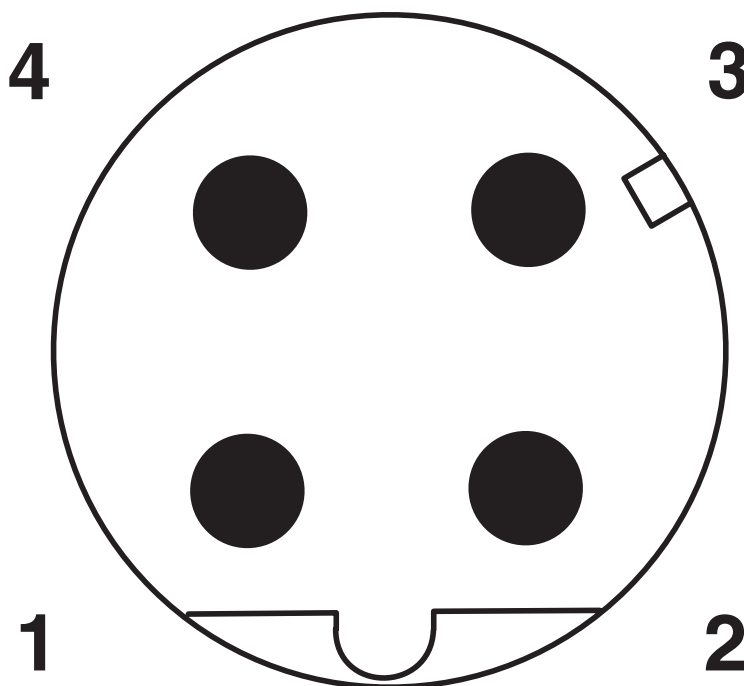

Pin assignment M12 male connector, 4-pos., D-coded, male side

Functional drawing

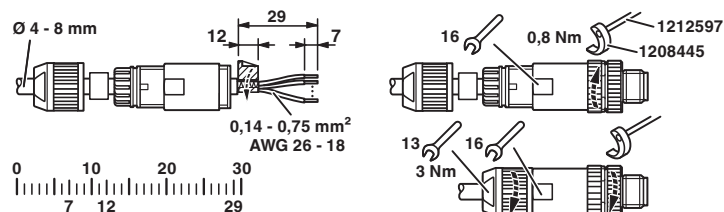

Slide the pressure nut and sleeve housing along the cable, strip the cable, shorten the shield, strip the single wires, connect the wires, in the case of a straight sleeve housing gently twist the wires together, stick the shielding foil around the shortened shield, in the case of a cable outside diameter <math>< 6 \text{ mm}</math> stick an additional shielding foil around the wire pack, screw the sleeve housing to the plug insert, screw the pressure nut tight.

SACC-M12MSD-4PL SH PN - Connector

1424682

<https://www.phoenixcontact.com/nl/producten/1424682>

Dimensional drawing

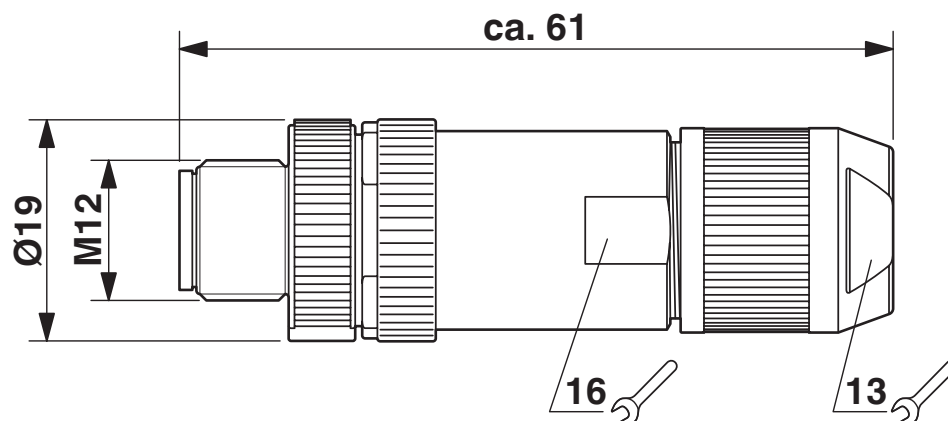

M12 SPEEDCON plug, straight, shielded

SACC-M12MSD-4PL SH PN - Connector





1424682

<https://www.phoenixcontact.com/nl/producten/1424682>

Approvals

To download certificates, visit the product detail page: <https://www.phoenixcontact.com/nl/producten/1424682>

 UL Listed Approval ID: E221474				
	Nominal voltage U_N	Nominal current I_N	Cross section AWG	Cross section mm^2
	60 V	4 A	-	26 - 18

 cUL Listed Approval ID: E221474				
	Nominal voltage U_N	Nominal current I_N	Cross section AWG	Cross section mm^2
	60 V	4 A	26 - 18	-

cULus Listed				
---------------------	--	--	--	--

SACC-M12MSD-4PL SH PN - Connector



1424682

<https://www.phoenixcontact.com/nl/producten/1424682>

Classifications

ECLASS

ECLASS-11.0	27440102
ECLASS-12.0	27440116
ECLASS-13.0	27440116

ETIM

ETIM 9.0	EC002635
----------	----------

UNSPSC

UNSPSC 21.0	39121400
-------------	----------

SACC-M12MSD-4PL SH PN - Connector



1424682

<https://www.phoenixcontact.com/nl/producten/1424682>

Environmental product compliance

EU RoHS

Fulfills EU RoHS substance requirements	Yes, No exemptions
---	--------------------

China RoHS

Environment friendly use period (EFUP)	EFUP-E
	No hazardous substances above the limits

EU REACH SVHC

REACH candidate substance (CAS No.)	No substance above 0.1 wt%
-------------------------------------	----------------------------

SACC-M12MSD-4PL SH PN - Connector



1424682

<https://www.phoenixcontact.com/nl/producten/1424682>

Accessories

PROT-M12 FS-PA-CHAIN - Sealing cap

1430873

<https://www.phoenixcontact.com/nl/producten/1430873>

M12 sealing cap made of plastic with fixing band, for sensor cables, for free M12 plugs



VS-OE-OE-93B/... - Data cable

1417362

<https://www.phoenixcontact.com/nl/producten/1417362>



By the meter, Data cable, PROFINET CAT5 (100 Mbps), EtherCAT® CAT5 (100 Mbps), shielded, PVC/PVC, green RAL 6018, 4-wire (1x4xAWG22/7, SF/TQ), color single wire: white, yellow, blue, orange, cable length: Free entry (0.5 ... 400 m)

SACC-M12MSD-4PL SH PN - Connector

1424682

<https://www.phoenixcontact.com/nl/producten/1424682>

VS-OE-OE-93C/... - Data cable

1417491

<https://www.phoenixcontact.com/nl/producten/1417491>



By the meter, Data cable, PROFINET CAT5 (100 Mbps), EtherCAT® CAT5 (100 Mbps), shielded, PUR/FRNC halogen-free, green RAL 6018, 4-wire (1x4xAWG22/7, SF/TQ), color single wire: white, yellow, blue, orange, cable length: Free entry (0.5 ... 400 m)

VS-OE-OE-93R/... - Data cable

1417388

<https://www.phoenixcontact.com/nl/producten/1417388>

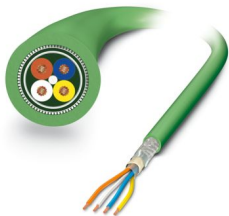

By the meter, Data cable, PROFINET CAT5 (100 Mbps), EtherCAT® CAT5 (100 Mbps), shielded, PUR halogen-free, green RAL 6018, 4-wire (1x4xAWG22/19, S/TQ), color single wire: white, yellow, blue, orange, cable length: Free input (0.5 ... 100 m)

SACC-M12MSD-4PL SH PN - Connector

1424682

<https://www.phoenixcontact.com/nl/producten/1424682>

VS-OE-OE-936/... - Data cable

1417375

<https://www.phoenixcontact.com/nl/producten/1417375>



By the meter, Data cable, PROFINET CAT5 (100 Mbps), shielded, PE-X halogen-free, black RAL 9005, 4-wire (1x4xAWG22/7, SF/TQ), color single wire: white-blue, orange-yellow, cable length: Free input (0.5 ... 100 m)

VS-OE-OE-937/... - Data cable

1402687

<https://www.phoenixcontact.com/nl/producten/1402687>



By the meter, Data cable, PROFINET CAT5 (100 Mbps), EtherCAT® CAT5 (100 Mbps), shielded, PE-X halogen-free, black RAL 9005, 4-wire (1x4xAWG22/7, SF/TQ), color single wire: white-blue, orange-yellow, cable length: Free entry (0.5 ... 400 m)

SACC-M12MSD-4PL SH PN - Connector



1424682

<https://www.phoenixcontact.com/nl/producten/1424682>

ALU-SB - Shielding foil

1404531

<https://www.phoenixcontact.com/nl/producten/1404531>

Shielding foil, for fixing the braided shield of shielded cables. Length: 4 cm, width: 1.2 cm



AI 0,25- 6 YE - Ferrule

3203024

<https://www.phoenixcontact.com/nl/producten/3203024>

Ferrule, Length contact range: 6 mm, sleeve length: 10.5 mm, color: yellow



SACC-M12MSD-4PL SH PN - Connector

1424682

<https://www.phoenixcontact.com/nl/producten/1424682>

A 0,25- 7 - Ferrule

3202478

<https://www.phoenixcontact.com/nl/producten/3202478>



Ferrule, Length contact range: 7 mm, sleeve length: 7 mm, color: silver

A 0,34- 7 - Ferrule

3009202

<https://www.phoenixcontact.com/nl/producten/3009202>



Ferrule, Length contact range: 7 mm, sleeve length: 7 mm, color: silver

SACC-M12MSD-4PL SH PN - Connector



1424682

<https://www.phoenixcontact.com/nl/producten/1424682>

A 0,5 - 6 - Ferrule

3200218

<https://www.phoenixcontact.com/nl/producten/3200218>



Ferrule, Length contact range: 6 mm, sleeve length: 6 mm, color: silver

AI 0,5 - 6 WH - Ferrule

3200687

<https://www.phoenixcontact.com/nl/producten/3200687>



Ferrule, Length contact range: 6 mm, sleeve length: 12 mm, color: white

SACC-M12MSD-4PL SH PN - Connector

1424682

<https://www.phoenixcontact.com/nl/producten/1424682>

TSD 04 SAC - Torque screwdriver

1208429

<https://www.phoenixcontact.com/nl/producten/1208429>



Torque screwdriver, with preset torque of 0.4 Nm and 4 mm hexagonal drive for M12 connectors

SACC BIT M12-D20 - Tool

1208445

<https://www.phoenixcontact.com/nl/producten/1208445>



Nut for assembling M12 connectors for assembly with a knurl diameter of 20 mm, for 4 mm hexagonal drive

SACC-M12MSD-4PL SH PN - Connector



1424682

<https://www.phoenixcontact.com/nl/producten/1424682>

TSD 08 SAC - Torque screwdriver

1212597

<https://www.phoenixcontact.com/nl/producten/1212597>



Torque screw driver with preset torque of 0.8 Nm, with 4 mm hexagon for accommodating SAC bits, two-component handle with non-slip grip

TSD-M 1,2NM - Torque screwdriver

1212224

<https://www.phoenixcontact.com/nl/producten/1212224>



Torque screw driver, accuracy as per EN ISO 6789 standard, adjustable from 0.3 - 1.2 Nm

SACC-M12MSD-4PL SH PN - Connector

1424682

<https://www.phoenixcontact.com/nl/producten/1424682>



TSD-M SAC-BIT ADAPTER - Adapter insert

1212600

<https://www.phoenixcontact.com/nl/producten/1212600>



Adapter bit for TSD-M...torque tools, E6.3-1/4" drive with 4 mm hexagon to accommodate SAC bits

VS-CABLE-STRIP-VARIO - Stripping tool

1657407

<https://www.phoenixcontact.com/nl/producten/1657407>

Stripping tool, for the multi-level stripping of shielded cables



SACC-M12MSD-4PL SH PN - Connector



1424682

<https://www.phoenixcontact.com/nl/producten/1424682>

WIREFOX 2,5 - Stripping tool

1212368

<https://www.phoenixcontact.com/nl/producten/1212368>



Stripping tool, for conductors and cables with a conductor cross section from 0.08 to 2.5 mm, self-adjusting, stripping length adjustable up to 15 mm, cutting capacity up to 6 mm² stranded/1.5 mm² solid

CRIMPFOX 6H - Crimping pliers

1212046

<https://www.phoenixcontact.com/nl/producten/1212046>



Crimping pliers, for ferrules without insulating collar according to DIN 46228 Part 1 and ferrules with insulating collar according to DIN 46228 Part 4, 0.14 mm² ... 6 mm², unlockable pressure lock, lateral entry

Phoenix Contact 2024 © - all rights reserved
<https://www.phoenixcontact.com>

PHOENIX CONTACT B.V.
Hengelder 56 6902 PA Zevenaar
Postbus 246 6900 AE Zevenaar
(0316) 59 17 20
sales@phoenixcontact.nl