

1

2

3

4

5

6

RevNo Revision note

Date

Signature

Checked

A

A

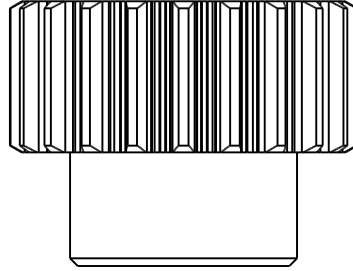
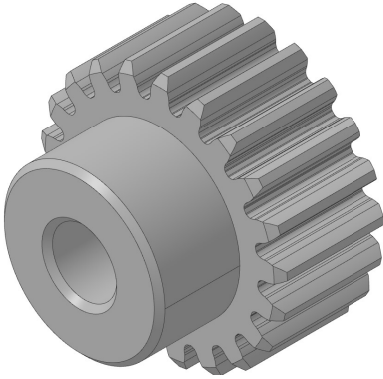

B

B

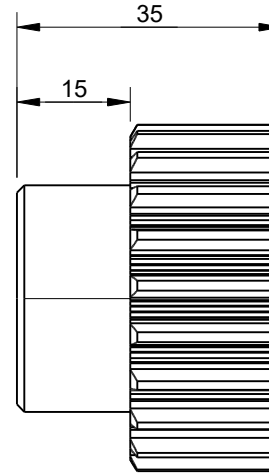
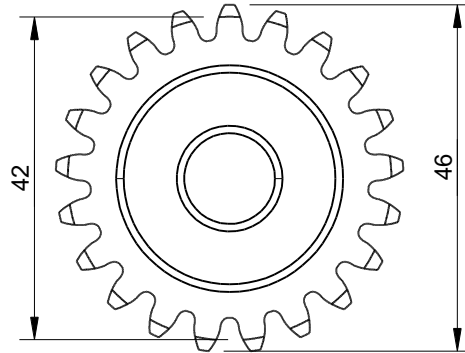
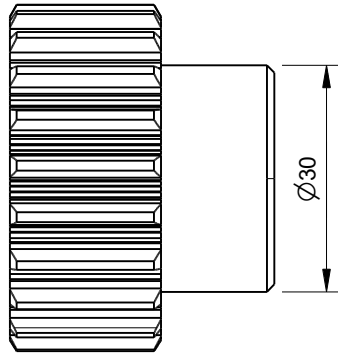

C

C

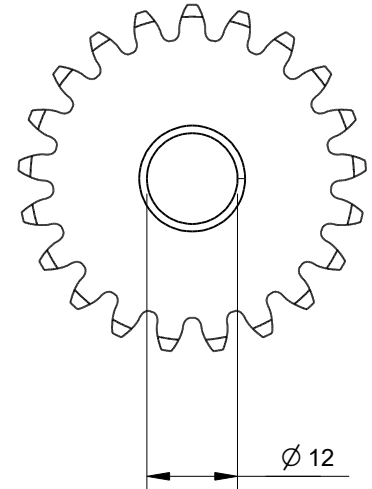

D

D

Number of Teeth (Z)	21
Module	2
Pressure Angle	20°
Outside Ø	46
Pitch Ø	42
Root Ø	37
Bore Ø	14
Material	Steel C45
Units	mm
Tolerances	+/- 0.1mm unless otherwise specified

Itemref	Quantity	Title/Name, designation, material, dimension etc	Article No./Reference		
Drawn by Kevin Damen	Checked by	Approved by - date	File name	Date 2-7-2024	Scale 1:1

861

www.damencnc.com

861 Module 2 Gear, with 21 teeth

Edition Sheet  
1 OF 1

1

2

3

4

5

6